



## **User Manual**

Presentation Switcher 5x2 incl. Scaler and PoH

**Model PT-PSW-52**

Designed in Germany

© 2016 PureLink GmbH All rights reserved.

## **Preface**

Read this user manual carefully before using this product. Pictures shown in this manual are for reference only. Different model layouts and specifications are subject to the physical product.

This manual is for operation instructions only, not for any maintenance usage.

In the constant effort to improve our product, we reserve the right to make changes in functions or parameters without prior notice or obligation.

## **Trademarks**

Product model and logo are trademarks. Any other trademarks mentioned in this manual are acknowledged as the properties of the trademark owner. No part of this publication may be copied or reproduced without the prior written consent.

## **FCC Statement**

This equipment generates, uses and can radiate radio frequency energy and, if not installed and used in accordance with the instructions, may cause harmful interference to radio communications. It has been tested and found to comply with the limits for a Class B digital device, pursuant to part 15 of the FCC Rules. These limits are designed to provide reasonable protection against harmful interference in a commercial installation.

Operation of this equipment in a residential area is likely to cause interference, in which case the user at their own expense will be required to take whatever measures may be necessary to correct the interference.

Any changes or modifications not expressly approved by the manufacture would void the user's authority to operate the equipment.

---

## SAFETY PRECAUTIONS

To insure the best from the product, please read all instructions carefully before using the device. Save this manual for further reference.

- Unpack the equipment carefully and save the original box and packing material for possible future shipment
- Follow basic safety precautions to reduce the risk of fire, electrical shock and injury to persons.
- Do not dismantle the housing or modify the module. It may result in electrical shock or burn.
- Using supplies or parts not meeting the products' specifications may cause damage, deterioration or malfunction.
- Refer all servicing to qualified service personnel.
- To prevent fire or shock hazard, do not expose the unit to rain, moisture or install this product near water.
- Do not put any heavy items on the extension cable in case of extrusion.
- Do not remove the housing of the device as opening or removing housing may expose you to dangerous voltage or other hazards.
- Install the device in a place with fine ventilation to avoid damage caused by overheat.
- Keep the module away from liquids.
- Spillage into the housing may result in fire, electrical shock, or equipment damage. If an object or liquid falls or spills on to the housing, unplug the module immediately.
- Do not twist or pull by force ends of the optical cable. It can cause malfunction.
- Do not use liquid or aerosol cleaners to clean this unit. Always unplug the power to the device before cleaning.
- Unplug the power cord when left unused for a long period of time.
- Information on disposal for scrapped devices: do not burn or mix with general household waste, please treat them as normal electrical wastes.



## Contents

1. Introduction.....	1
1.1 Introduction to the Scaler Switcher .....	1
1.2 Features .....	1
1.3 Package List.....	2
2. Panel Description.....	3
2.1 Front Panel.....	3
2.2 Rear Panel.....	4
3. System Connection.....	6
3.1 Usage Precautions.....	6
3.2 System Diagram.....	6
3.3 Connection Procedure.....	7
3.4 Connection of Microphone.....	8
3.5 Application.....	10
4. System Operations.....	11
4.1 Front Panel Buttons.....	11
4.1.1 Manual-Switchin.....	11
4.1.2 Auto-Switching.....	11
4.1.3 Volume Adjusting .....	12
4.2 IR Control.....	13
4.2.1 IR Remote .....	13
4.2.2 Control far-end device from local .....	14
4.2.3 Control local device from remote.....	14
4.2.4 CEC Function.....	15
4.3 RS232 Control .....	17
4.3.1 Installation/uninstallation of RS232 Control Software.....	17
4.3.2 Basic Settings .....	17
4.3.3 RS232 Communication Commands.....	19
4.3.4 Control Compact Scaler Switcher or 3rd Party Device from Local.....	29
4.3.5 Control Compact Scaler Switcher or 3rd party device form Remote.....	30

---

- 4.4 OSD Menu Control.....31
  - 4.4.1 OPTIONS.....31
  - 4.4.2 PICTURE.....33
  - 4.4.3 SETUP.....34
- 4.5 Web-based GUI Control.....35
  - 4.5.1 Control Menu .....36
  - 4.5.2 Configuration Menu .....37
  - 4.5.3 RS232 Control Menu.....40
  - 4.5.4 Password Menu .....41
  - 4.5.5 Web-based GUI Update.....42
- 5. Specification.....43
- 6. Panel Drawing.....45
- 7. Troubleshooting & Maintenance .....46
- 8. After-sales Service .....47

---

## 1. Introduction

### 1.1 Introduction to the Scaler Switcher

The PT-PSW-52 (hereinafter referred to as „Scaler Switcher“) is a compact mini scaler switcher with 5 video inputs (1 HDMI/MHL, 2 HDMI, 1 DP, and 1 VGA) and 3 audio inputs (1 DP external audio, 1 VGA auxiliary audio, 1 MIC audio). The VGA input supports VGA, YPbPr and C-video, so the device switcher is compliant with multiple video signals.

The Scaler Switcher scales & switches any video signal to HDMI output and HDBaseT output (supports PoH and connects to an HDBaseT Receiver, up to a maximum transmission distance of 70 meters).

With 1 IR IN, 1 IR OUT & 1 RS232, the IR & RS232 signals can be transmitted bi-directionally between the Scaler Switcher and the HDBaseT Receiver.

In addition, the Scaler Switcher can be controlled via front panel buttons, IR remote, RS232 commands and web-based GUI.

### 1.2 Features

- Compliant with HDMI1.4& HDCP2.2.
- Supports CEC, with commands to enable/disable this function.
- Supports video source auto-switching function.
- Bi-directional IR & RS232 control.
- Output resolutions selectable to assure preferred output, and supports various output resolutions, such as 1920x1200, 1920x1080, 1600x1200, 1600x900, 1360x768, 1280x800, 1280x720, 1024x768.
- VGA video supports C-video, YPbPr and VGA.
- 48V phantom power to support condenser microphone.
- MIC port supports balance/unbalance signal, suppress the external noise effectively.
- 3-level MIC input, supports condenser microphone, dynamic microphone and wireless microphone.
- Controllable via buttons, IR remote, RS232 & Web-based GUI.
- Powerful OSD function.
- Supports online software upgrading.

### 1.3 Package List

- 1 x Compact Scaler Switcher
- 2 x Mounting Ears with 4 screws
- 2 x Long Mounting Ears with 6 screws (Optional)
- 1 x Power Adapter (24VDC,2.71A)
- 4 x Plastic Cushions
- 1 x IR Remote
- 1 x VGA converting cable (VGA to YPbPr)
- 1 x HDBaseT Receiver
- 2 x Mounting Ears with 4 screws for HDBaseT receiver
- 4 x Plastic Cushions for HDBaseT receiver
- 1 x RS232 cable (3-Pin phoenix connector to DB9)
- 2 x 3-Pin phoenix connectors
- 1 x 5-Pin phoenix connector
- 1 x IR Emitter
- 1 x IR Receiver (with carrier wave)
- 1 x User Manual

**Note:** Please confirm if the product and the accessories are all included, if not, please contact with the dealers.

## 2. Panel Description

### 2.1 Front Panel

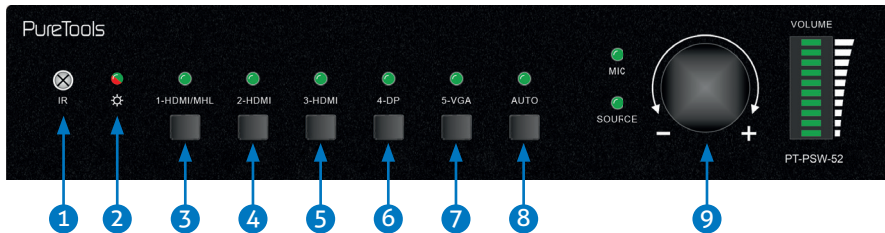

1. Built-in IR Receiver
2. Power indicator
  - Off when there is no power to the device
  - Green when the device is in standby mode
  - Red when the device is powered on.
3. 1-HDMI/MHL input Selector & Activity LED
4. 2-HDMI input Selector & Activity LED
5. 3-HDMI input Selector & Activity LED
6. 4-DisplayPort input Selector & Activity LED
7. 5-VGA input Selector Activity LED
8. Auto-Switching Mode Selector& Activity LED
  - Press this button to enter or exit Auto-switching mode, in this mode, select input source via front panel button is not available, but RS232 command and IR remote are able to switch mode. The auto LED turn green and keep on.

**Note:** When you set any VGA port to C-video or YPbPr in Manual-switching mode, the system will not be able to enter Auto-switching mode.

9. Volume Knob

**Note:** Pictures shown in this manual are for reference only. Different model layouts and specifications are subject to the physical product.



## 2.2 Rear Panel

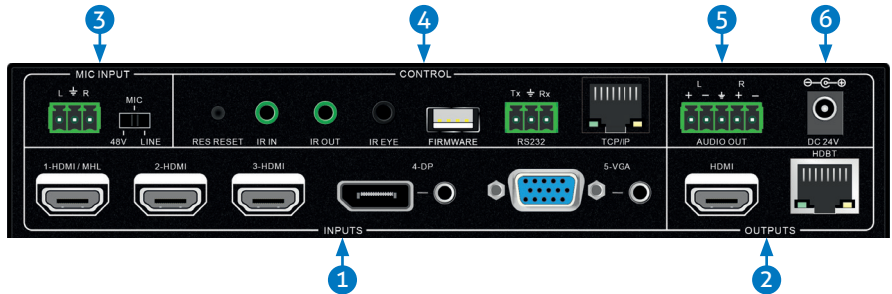

### 1. INPUTS

- Video input ports: 1 HDMI/MHL input, 2 HDMI inputs, 1 DP and 1 VGA
- Audio input ports: 1 DP external audio input and 1 VGA auxiliary audio input.

### 2. OUTPUTS

- HDMI output: HDMI video output port
- HDBaseT output: Support PoH. Connect with an HDBaseT Receiver to transmit AV signal or IR/RS232 control signal.

HDBaseT output boasts green and yellow indicators. The green indicator will blink when powered. If connected to an HDBaseT receiver to this output successfully, the yellow indicator will light up, and the green indicator will keep blinking.

### 3. MIC INPUT

- MIC audio port: connect to Microphone.
- Dial switch: including 3 level
  - 48V phantom power mode (connect with condenser microphone);
  - MIC mode (connect with dynamic microphone);
  - LINE mode (connect with wireless microphone or line audio).

#### 4. CONTROL

- RES RESET: press this button to reset the output resolution to 1280×720p.
- IR IN: connect with IR receiver (with carrier wave only) to receive IR signal to control far-end device which was connected to HDBaseT Receiver via HDBaseT output port.
- IR OUT: connect with IR emitter to control local source devices from remote.
- IR EYE: connect with IR receiver (with carrier wave only) to receive IR signal send by IR remote to control this Scaler Switcher.
- FIRMWARE: Type-A USB port for updating system firmware or loading customized EDID data.
- RS232: Serial port, 3-pin phoenix connector, connect with a control device (such as PC) to control the Scaler Switcher or other devices connected with HDBaseT Receiver.
- TCP/IP: Ethernet port, connect with PC to control the Scaler Switcher via Web-based GUI.

#### 5. AUDIO OUTPUT

- Audio output port, the audio comes from the input audio corresponding to the selected video source and is mixed with MIC audio.

#### 6. DC 24V

- Power port, connect with DC 24V power adapter.

**Note:** Pictures shown in this manual are for reference only. Different model layouts and specifications are subject to the physical product.

### 3. System Connection

#### 3.1 Usage Precautions

- The system should be installed in a clean environment and is subject to the specified temperature and humidity.
- All of the power switches, plugs, sockets and power cords should be insulated and safe.
- All devices should be connected before powered on.

#### 3.2 System Diagram

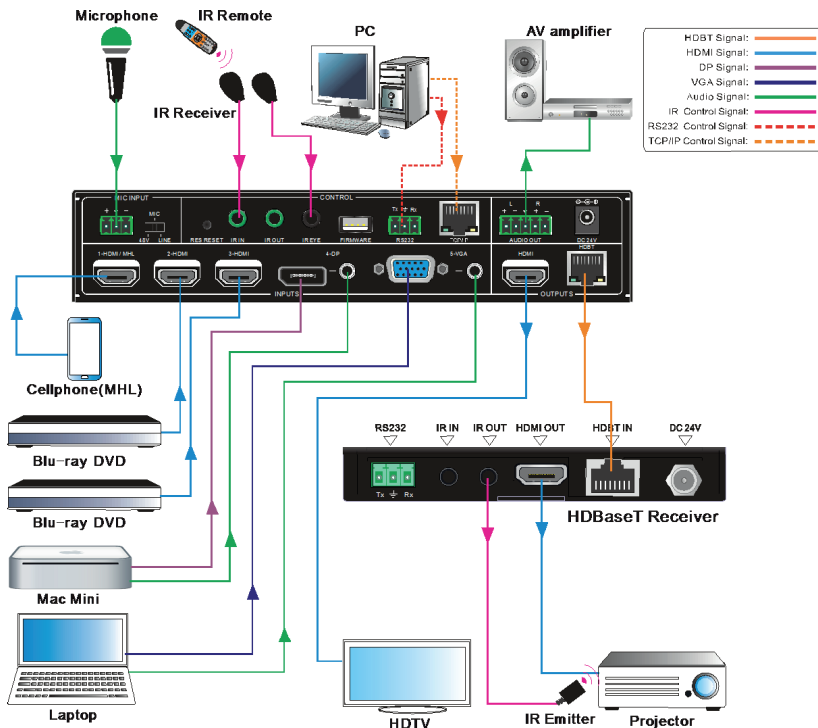

### 3.3 Connection Procedure

- Step1.** Connect HDMI source devices (e.g. BluRay / DVD) to 1~3 HDMI input ports with HDMI cable
- Step2.** Connect a DisplayPort source device (e.g. MAC MINI) to DP input port with DisplayPort cable and DP audio input port with audio cable.
- Step3.** Connect a VGA source device (e.g. Laptop) to VGA input port with VGA cable and VGA audio input port with audio cable.
- Step4.** Select MIC level and connect right microphone to MIC input port. MIC audio will be transmitted to AUDIO OUTPUT port and mixed with source audio.
- Step5.** Connect a HDMI display device to HDMI output port with HDMI cable.
- Step6.** Connect HDBaseT Receiver to HDBT output port with twisted pair.
- Step7.** Connect speaker, headphone or AV amplifier to AUDIO OUTPUT port.
- Step8.** Connect control device (e.g. PC) to the TCP/IP port, the Scaler Switcher can be controlled via web-based GUI.
- Step9.** Connect control device (e.g. PC) to the RS232 port of the Scaler Switcher or the HDBaseT Receiver (bi-directional RS232 control, either end is available).
- Step10.** Connect IR receiver to the IR EYE port, the Scaler Switcher can be control via IR remote. For more details, please refer to 4.2.IR Control.
- Step11.** Both the Scaler Switcher and the HDBaseT Receiver have IR IN and OUT. When one model is connected with IR receiver, the other model should connect with an IR transmitter.  
For example: When "IR IN" of the Scaler Switcher connects with an IR receiver, the IR transmitter must connect to IR OUT of HDBaseT Receiver. The IR signal can be transmitted bi-directionally between the Scaler Switcher and the HDBaseT Receiver.
- Step12.** Connect DC24V power adaptor to the power port (HDBaseT Receiver can be powered by the Scaler Switcher with PoH function).

**Note:** If the power adaptor is connected to an HDBaseT Receiver, the Scaler Switcher can't be powered from HDBaseT Receiver.

### 3.4 Connection of Microphone

The Scaler Switcher provides with one 3-level microphone input port, to accommodate different microphone input modes, including 48V phantom power mode, MIC mode & LINE mode.

#### » 48V phantom power Mode

48V phantom power input has a good frequency characteristic, high input impedance and high sensitivity.

When switching to "48V", the MIC input will provide a 48V phantom power. This is only used for **condenser microphones**.

Connect the microphone in this way: "+" connects to positive, "-" connects to negative and "⏏" to ground.

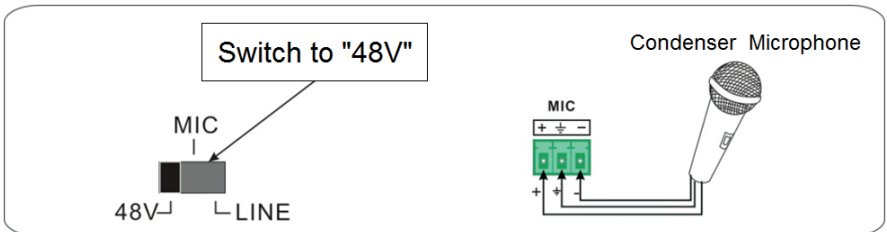

» MIC Mode

MIC input has a low frequency characteristics, and wide frequency response. When switch to "MIC", the microphone input is used for connecting with dynamic microphone. There are two different connection methods:

1) Unbalanced connection:

- "+" and "⏏" connect to ground, and "-" connects to signal.
- "-" and "⏏" connect to ground, and "+" connects to signal.

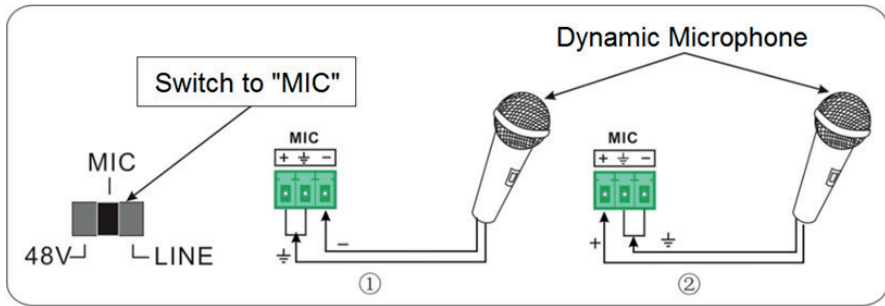

2) Balanced connection: "+" connects to positive, "-" connects to negative and "⏏" connects to ground.

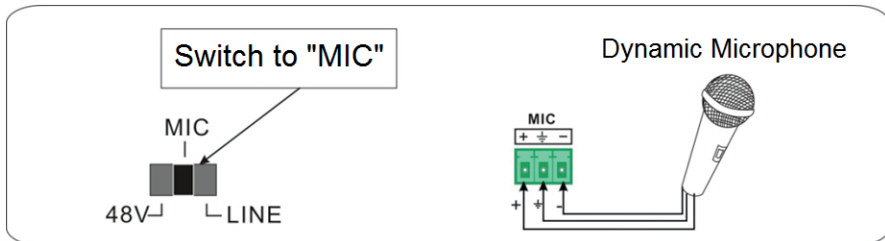

» **LINE Mode**

LINE input has a low frequency characteristics, and wide frequency response. When switch to "LINE", the microphone input is used for connecting with line audio or wireless microphone output. There are two different connection methods:

1) **Unbalanced connection:**

- "+" and "⊥" connect to ground, and "-" connects to signal.
- "-" and "⊥" connect to ground, and "+" connects to signal.

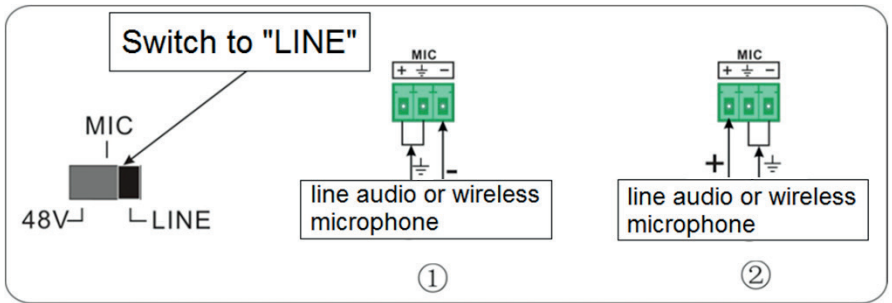

2) **Balanced connection:** "+" connects to positive, "-" connects to negative and "⊥" connects to ground.

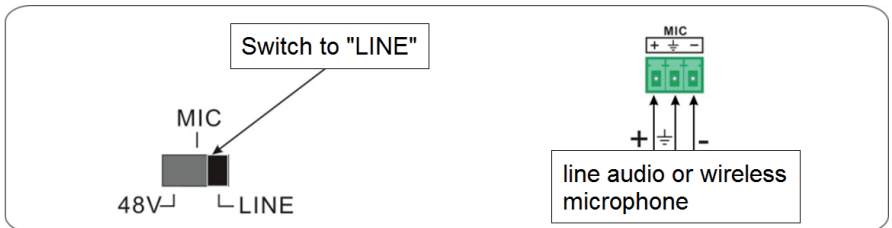

### 3.5 Application

The Scaler Switcher is good for applications in various occasions, such as PC streaming, monitoring, conference room applications, big screen displaying, television education, in command & control centers and smart homes, etc.

## 4. System Operations

### 4.1 Front Panel Buttons

Front panel buttons can be used for switching operations and volume adjusting.

#### 4.1.1 Manual-Switching

Press **1-HDMI/MHL**, **2-HDMI**, **3-HDMI**, **4-DP**, **5-VGA** on front panel to select the corresponding input source.

#### 4.1.2 Auto-Switching

Press **AUTO** to enter in auto-switching mode.

The auto-switching mode abides by the following principles:

» **New input**

Once detecting a new input signal, the switcher would switch to this new signal automatically.

» **Rebooting device**

The Scaler Switcher have the ability to save the last configuration before losing power. If the last switching mode is auto-switching, once rebooted, the switcher will automatically enter auto-switching mode, then detect all inputs and memorize their connection status for future rebooting using. If the last displayed signal is still available, the unit will output the signal. If not, the unit will detect all the input signals with priority from 1-HDMI/MHL to 5-VGA. When the first signal is detected, it will transfer to the output.

» **Signal removing**

Once removing the current display signal, the Scaler Switcher will detect all input signals with priority from 1-HDMI/MHL to 5-VGA. It will then transfer the first detected available signal to the output devices.



**Note:** Auto-switching function works only when inputting new signal, removing a signal or power rebooting. With any VGA port set to C-video or YPbPr, the system will be not able to enter in Auto-switching mode.

### 4.1.3 Volume Adjusting

Press Volume Knob to choose MIC/Source audio needed to be adjusted, the corresponding LED will turn green and keep on.

- Adjusting the Volume Knob in clockwise direction to increase sound volume.
- Adjusting the Volume Knob in anti-clockwise direction to decrease sound volume.

## 4.2 IR Control

### 4.2.1 IR Remote

Connect IR receiver to IR EYE port, the Scaler Switcher can be controlled by using IR remote. As CEC function, it is able to use the IR remote to turn on/off the HDMI source or Display.

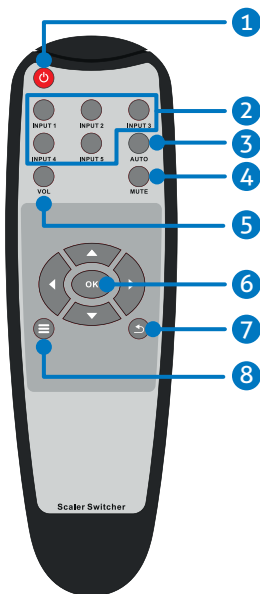

1. Enter/ exit standby mode
2. Input channel selection buttons: Select video source via pressing corresponding button (audio switched following the corresponding DP/VGA )
3. Auto button: Enter/Exit auto-switching mode.
4. Mute/ unmute audio
5. Volume adjusting button: After pressing this button, the volume adjusting menu will be showed on Display, and then press UP/DOWON button to increase/decrease volume.
6. OK: confirm button; Navigation buttons: UP/DWON LEFT/ RIGHT button, for value setting or page-turn.
7. Exit button: Exit OSD menu or current operation.
8. Enter OSD menu or used to return to previous menu.

### 4.2.2 Control far-end device from local

Connect an IR receiver to IR IN port on the Scaler Switcher and connect IR emitter to the IR OUT port on the HDBaseT Receiver, the far-end device can be controlled by its IR remote from local.

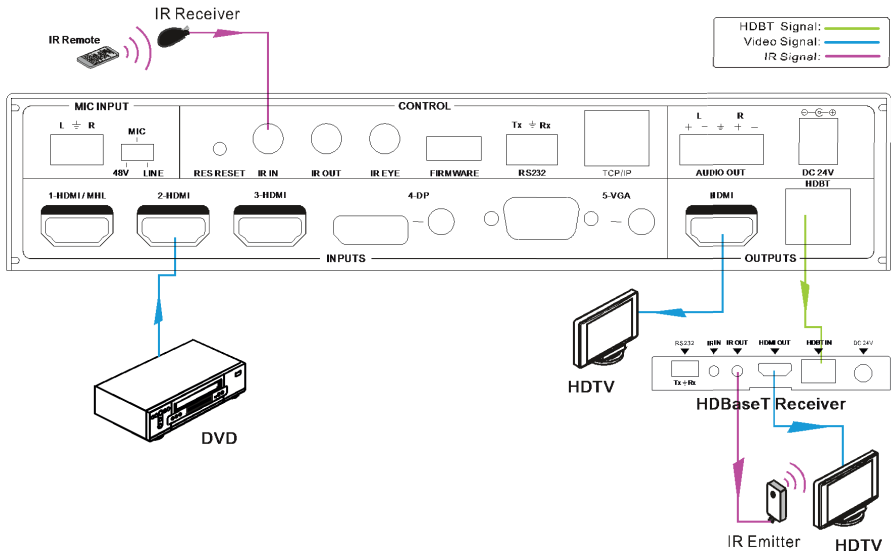

### 4.2.3 Control local device from remote

Connect an IR emitter to IR OUT port on the Compact Scaler Switcher and connect IR receiver to the IR IN port on the HDBaseT Receiver, the source devices can now be remotely controlled by the IR remote.

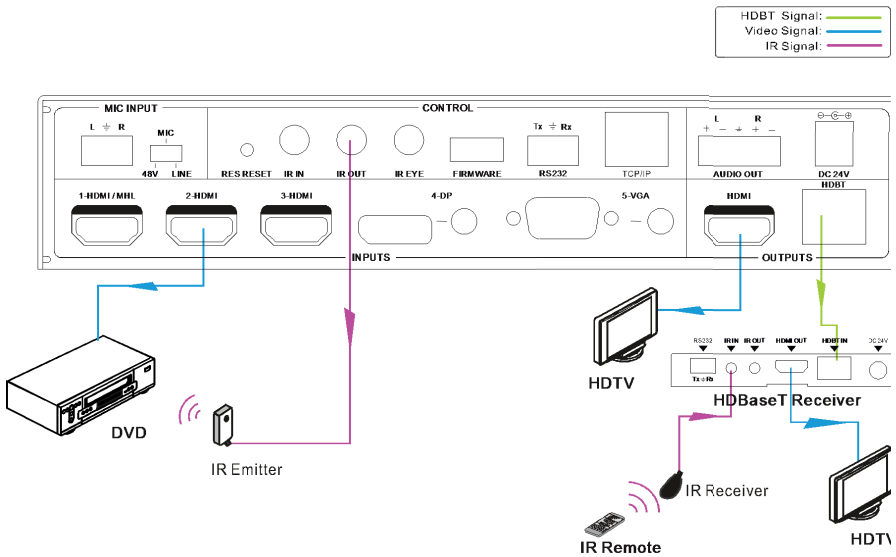





#### 4.2.4 CEC Function

The Scaler Switcher supports CEC, it can be turned on/ off by sending RS232 commands or OSD menu operations. The default setting is ON.

Commands pertaining to CEC: "50686%" (enable CEC) and "50687%" (disable CEC)

HDMI INPUT ports 1~3 support CEC, if the connected source devices also support CEC and their CEC are on, users can control the source device and display via the IR remote of the Scaler Switcher.

The working status related to CEC and STANDBY is shown as below:

Situation	Working Status
CEC: on, Standby: on	Press STANDBY button on IR remote, the Scaler Switcher enters in standby mode, so do all HDMI source devices and display. Press STANDBY button again on IR remote, the Scaler Switcher exits standby mode, the previous selected HDMI input source device and display start working too.
CEC: on, Standby: off	Press STANDBY button on IR remote, the Scaler Switcher enters in standby mode, HDMI 1~3 source devices and display stay on.
CEC: on	Use  ,  ,  ,  ,  and buttons on IR remote to control HDMI source device.
CEC: off	Unable to control HDMI source device and display through IR

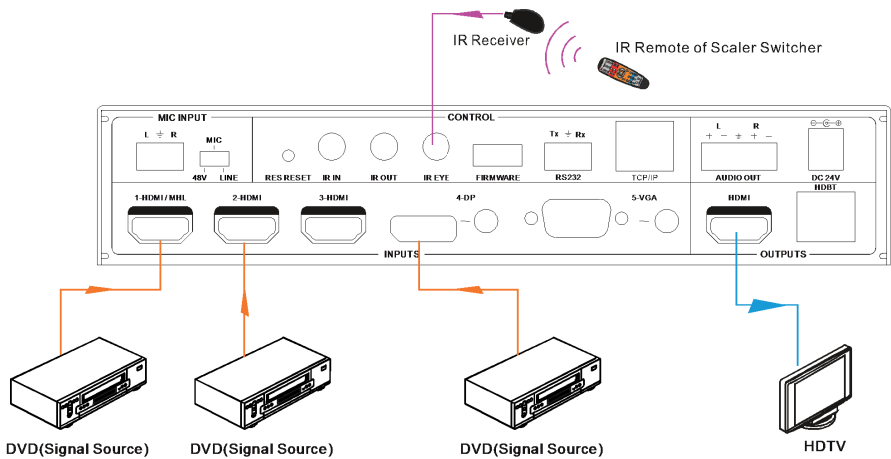

## 4.3 RS232 Control

As RS232 can be transmitted bi-directionally between the Scaler Switcher and the HDBaseT Receiver, so it is able to control a third party RS232 device from local or control the Scaler Switcher from remote. The baud rate support 2400, 4800, 9600(default), 19200, 38400, 57600 or 115200.

### 4.3.1 Installation/uninstallation of RS232 Control Software

- **Installation** Copy the control software file to the computer connected with the Scaler Switcher.
- **Uninstallation** Delete all the control software files in corresponding file path.

### 4.3.2 Basic Settings

First connect the Scaler Switcher with all input devices and output devices needed, then connect it with a computer which is installed with RS232 control software. Double-click the software icon to run this software.

Here we take the software **CommWatch.exe** as example. The icon is showed as below:



The interface of the control software is shown as below:

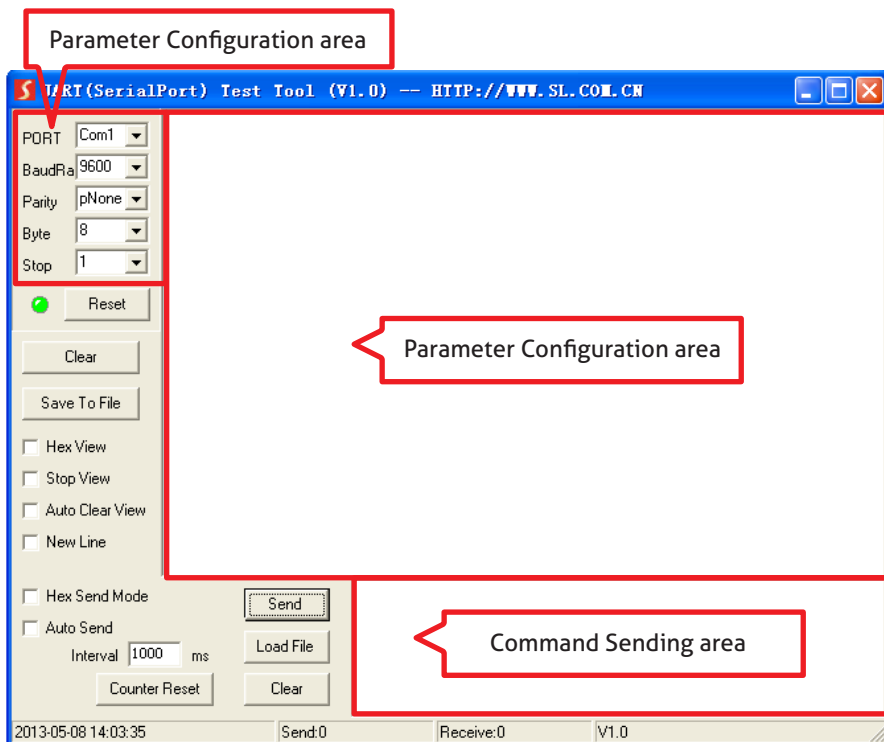

Please set the parameters of COM number, bound rate, data bit, stop bit and the parity bit correctly, and then you are able to send command in Command Sending Area.

### 4.3.3 RS232 Communication Commands

Communication protocol: RS232 Communication Protocol

Baud rate: 9600    Data bit: 8    Stop bit: 1    Parity bit: none

Command	Function	Feedback Example
<b>Switch Commands</b>		
50701%	Switch to 1-HDMI/MHL input	Switch to HDMI 1
50702%	Switch to 2-HDMI input	Switch to HDMI 2
50703%	Switch to 3-HDMI input	Switch to HDMI 3
50704%	Switch to 4-DP input	Switch to DP
50705%	Switch to 5-VGA input	Switch to VGA 1/YPbPr/ AV
50683%	Set the signal format to VGA for 5-VGA input	Input 5 Set & Switch to VGA
50684%	Set the signal format to YPbPr for 5-VGA input	Input 5 Set & Switch to YPbPr
50685%	Set the signal format to AV(C-video) for 5-VGA input	Input 5 Set & Switch to AV
50785%	Enable auto-switching	Auto Switching
50786%	Disable auto-switching	Manual Switching
<b>Audio Commands</b>		
50600%	MUTE Source audio	Source Mute
50601%	UnMute Source audio	Source Unmute
50602%	Increase the volume of source audio	Source Volume: xx (xx=00-60)
50603%	Decrease the volume of source audio	Source Volume: xx (xx=00-60)
50722%	Mute MIC audio	MIC Mute
50723%	Unmute MIC audio	MIC Unmute
50726%	Mute VGA audio	VGA audio Mute
50727%	Unmute VGA audio	VGA audio Unmute



Command	Function	Feedback Example
50728%	Mute DP audio	DP audio Mute
50729%	Unmute DP audio	DP audio Unmute
50724%	Increase the volume of MIC audio	MIC Volume: xx (xx=00~60)
50725%	Decrease the volume of MIC audio	MIC Volume: xx (xx=00~60)
508xx%	Set the volume of MIC audio	MIC Volume: xx (xx=00~60)
510xx%	Set the volume of source audio	Source Volume: xx (xx=00~60)
50706%	Select embedded audio as audio input for DP video signal	DP Audio from Embedded
50707%	Select external audio as audio input for DP video signal	DP Audio from External
Resolution Commands		
50619%	Set the output resolution to 1360X768 HD	Resolution: 1360x768
50626%	Set the output resolution to 1024X768 XGA	Resolution: 1024x768
50627%	Set the output resolution to 1280X720 720P	Resolution: 1280x720
50628%	Set the output resolution to 1280X800 WXGA	Resolution: 1280x800
50629%	Set the output resolution to 1920X1080 1080P	Resolution: 1920x1080
50620%	Set the output resolution to 1920X1200 WUXGA	Resolution: 1920x1200
50621%	Set the output resolution to 1600X1200 UXGA	Resolution: 1600x1200

Command	Function	Feedback Example
<b>Setup Commands</b>		
50604%	Lock the front panel buttons	Front Panel lock
50605%	Unlock the front panel buttons	Front Panel Unlock
502xx%	Set the brightness to xx.	Brightness: xx (xx=00-99)
503xx%	Set the contrast to xx.	Contrast: xx (xx=00-99)
504xx%	Set the saturation to xx.	Saturation: xx (xx=00-99)
505xx%	Set the sharpness to xx.	Sharpness: xx (xx=00-99)
50607%	Adjust the color temperature	Color Temperature: xx (xx= Cool/ Medium/ Warm/ User.)
50608%	Set the aspect ratio	Aspect Ratio: xx (xx= 16:9/ 4:3/ auto)
50614%	Set the picture mode	Picture Mode: xx (xx= dynamic/ standard/ mild/ user)
50655%	Freeze output image	Freeze: enable
50656%	Cancel the freezing of output image	Freeze: disable
50646%	Enable MIC Volume Icon display	Volume Icon: enable
50647%	Disable MIC Volume Icon display	Volume Icon: disable
50761%	Disable the mute icon of Source audio display	Source Mute Icon: disable
50762%	Enable the mute icon of Source audio display	Source Mute Icon: enable
50763%	Disable the mute icon of MIC audio display	MIC Mute Icon: disable
50764%	Enable the mute icon of MIC audio display	MIC Mute Icon: enable

Command	Function	Feedback Example
50765%	Enable the freeze icon display	Freeze Icon: enable
50766%	Disable freeze icon display	Freeze Icon: disable
50644%	Enable channel status display	Input Icon: enable
50645%	Disable channel status display	Input Icon: disable
50650%	Check the channel status	Input Icon: xx
50606%	Auto-adjust the input parameter(VGA only)	VGA Input Auto
50699%	Check the system version	Version Vx.x.x
50688%	Enable MIC noise detecting	MIC detect: enable
50689%	Disable MIC noise detecting	MIC detect: disable
50690%	Check MIC noise detecting statue	MIC detect: XXXX
50791%	HDCP Active mode	HDCP Active
50792%	HDCP Manual mode	HDCP Manual
50793%	Enable HDCP output	HDCP ON
50794%	Disable HDCP output	HDCP OFF
50795%	Inquire HDCP/ Manual HDCP	HDCP Manual
		HDCP OFF/ON
50767%	Restore default EDID	EDID: initial
50768%	Bypass EDID data from output to input	EDID: bypass
	input	
50769%	Upload custom EDID data to the switcher	EDID: user
50770%	Inquire EDID status	EDID: initial
		EDID: bypass
		EDID: user
50782%	EDID management, copy the best resolution data of one output to HDMI input	EDID manage
		Resolution:1920x1080

Command	Function	Feedback Example
50787%	Enable serial control mode 1: control Scaler & far-end from local RS232	RS232 Mode 1: RS232 Control Scaler & Remote
50788%	Enable serial control mode 2: control Scaler from local RS232 and far-end)	RS232 Mode 2: RS232 Control Scaler
50714%	Auto Switch Mode: Disable the automatic power off function	Auto Switch Mode: Set no input to power off function: Disable
50715%	Auto Switch Mode: Set the automatic power off time to 1 minute for No signal input	Auto Switch Mode: Set no input to power off time: 1 minute
50716%	Auto Switch Mode: Set the automatic power off time to 2 minutes for No signal input	Auto Switch Mode: Set no input to power off time: 2 minutes
50717%	Auto Switch Mode: Set the automatic power off time to 5 minutes for No signal input	Auto Switch Mode: Set no input to power off time: 5 minutes
50718%	Auto Switch Mode: Set the automatic power off time to 10 minutes for No signal input	Auto Switch Mode: Set no input to power off time: 10 minutes
50719%	Check the automatic power off time	Auto Switch Mode: Set no input to power off time: 1 minutes
		Manual Switch Mode: Set no input to power off function: Disable

Command	Function	Feedback Example
50740%	Manual Switch Mode: Disable automatic power off function	Manual Switch Mode: Set no input to power off time: 0 minutes
50741%	Manual Switch Mode: Set the power off time to 1 minute	Manual Switch Mode: Set no input to power off time: 1 minute
50742%	Manual Switch Mode: Set the power off time to 2 minute	Manual Switch Mode: Set no input to power off time: 2 minutes
50743%	Manual Switch Mode: Set the power off time to 5 minute	Manual Switch Mode: Set no input to power off time: 5 minutes
50744%	Manual Switch Mode: Set the power off time to 10 minute	Manual Switch Mode: Set no input to power off time: 10 minutes
50697%	Exit standby mode	Wake up!
50797%	Enter standby mode	Go to standby!
50698%	Software update	Software update
50617%	Reset to factory defaults	Factory Reset
Menu Commands		
50609%	OK for OSD selection	Key: ok
50610%	LEFT button	Key: left
50611%	RIGHT button	Key: right
50612%	UP button	Key: up
50613%	DOWN button	Key: down
50616%	MENU button (enter OSD)	OSD: Enter
50618%	EXIT button (exit OSD)	OSD: Exit

Command	Function	Feedback Example
<b>Inquire Commands</b>		
50630%	Check the volume level	Source Volume: xx (xx=00-60)
		MIC Volume: xx (xx=00-60)
50631%	Check the input source	Input: xx (xx= HDMI1/ HDMI2/ HDMI3/ DP/ VGA/ YPbPr/ AV)
50633%	Check the image mode	Picture Mode: xx (xx= Dynamic/ Standard/ Mild/ User)
50635%	Check the image aspect ratio	Aspect Ratio: xx (xx= 16:9/ 4:3/ auto/)
50636%	Check the brightness	Brightness: xx (xx=00-99)
50637%	Check the contrast	Contrast: xx (xx=00-99)
50638%	Check the saturation	Saturation: xx (xx=00-99)
50639%	Check sharpness	Sharpness: xx (xx=00-99)
50640%	Check the color temperature	Color Temperature: xx (xx= Cool/ Medium/ Warm/ User.)
50651%	Check Volume Icon display status	Volume Icon: xxxx

Command	Function	Feedback Example
50712%	Check the audio input sources for DP	DP Audio from Embedded
50751%	Check whether the Source audio is mute or not	Source Mute/Unmute
50752%	Check whether the MIC audio is mute or not	MIC Mute/Unmute
50753%	Check the freeze status	Freeze: enable/disable
50754%	Check the panel locked status	Front Panel Lock/UnLock
50783%	Display statues including MIC, Source audio, Resolution, Manual/ Auto-switching modes, VGA audio mute on/off, DP audio status	Source Volume: XX
		Mic Volume: XX
		Input: XXXX
		Resolution: XXXX
		LINE Mute/Unmute
		MIC Mute/Unmute
		Switch status: XXXX
		VGA Mute/Unmute
		DP Mute/Unmute
DP Audio from Embedded/External		
50657%	Check IP address	192.168.0.178!
50712%	Check DP audio path	DP Audio from Embedded/External
Adjustment Commands		
50678%	Enable screen output adjusting	Enter Output Position Adjust
50679%	Disable screen output adjusting	Exit Output Position Adjust
50670%	<i>Move the image to left</i>	<i>Output Position Adjust X xx</i>
50671%	<i>Move the image to right</i>	<i>Output Position Adjust X xx</i>

Command	Function	Feedback Example
50672%	Move the image up	Output Position Adjust Y XX
50673%	Move the image down	Output Position Adjust Y xx
50674%	Stretch left from left side (increase image width)	Output Width Adjust xx
50675%	Pull right from left side (decrease image width)	Output Width Adjust xx
50676%	Stretch upwards from bottom side (decrease image height)	Output Height Adjust xx
50677%	Stretch downwards from bottom side (increase image height)	Output Height Adjust xx
50730%	Turn off HDMI output	HDMI power off
50731%	Turn on HDMI output	HDMI power on
50732%	Turn off HDBT output	HDBT power off
50733%	Turn on HDBT output	HDBT power on
50734%	Turn on HDMI& HDBT output synchronously	HDMI HDBT power on
CEC Commands		
50687%	Disable CEC	HDMI CEC OFF
50686%	Enable CEC	HDMI CEC ON
50901%	Play & pause	CEC cmd: play&pause
50902%	Stop	CEC cmd: stop
50903%	Menu	CEC cmd: menu
50904%	Retreat	CEC cmd: rev
50905%	Forward	CEC cmd: fwd
50906%	Up	CEC cmd: up
50907%	Down	CEC cmd: down
50908%	Left	CEC cmd: left



50909%	Right	CEC cmd: right
50910%	Confirm command	CEC cmd: select
50911%	Exit command	CEC cmd: exit
50913%	Source power on	Source power on
50914%	Source power off	Source power off
50920%	TV power on	Display power on
50921%	TV power off	Display power off

**Note:**

- *Screen output adjusting avails only when the screen output adjusting is on. Send command 50678% to turn on.*
- *CEC commands with grey background avails only when CEC is on.*

### 4.3.4 Control Compact Scaler Switcher or 3rd Party Device from Local

First, according to the following connection diagram, connect all devices as needed.

Second, send command 50787% (serial control mode 1, factory default) via RS232 communication software.

Last, send the right command of the Scaler Switcher or other remote RS232 device connected in present system. Connect as below:

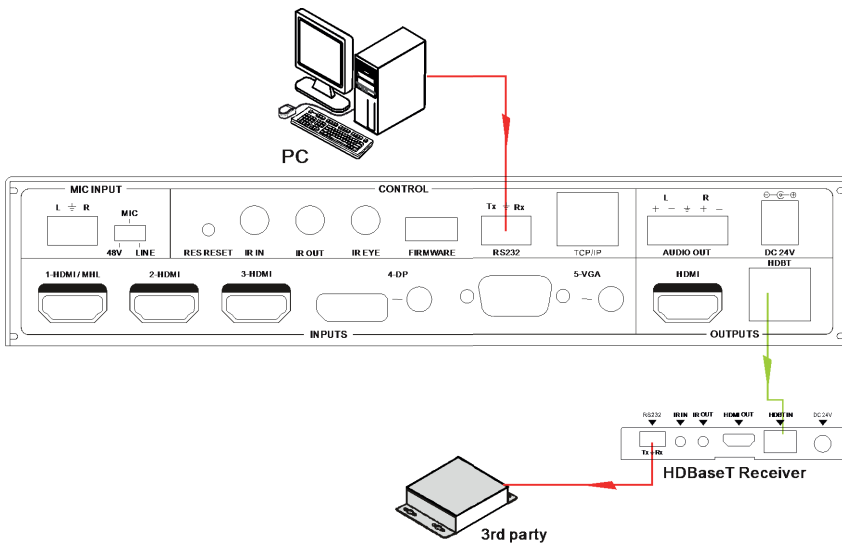

### 4.3.5 Control Compact Scaler Switcher or 3rd party device form Remote

First, according to the following connection diagram, connect all devices as needed.

Second, send command 50788% via RS232 communication software.

Last, send the right command to control the Scaler Switcher. Connect as below:

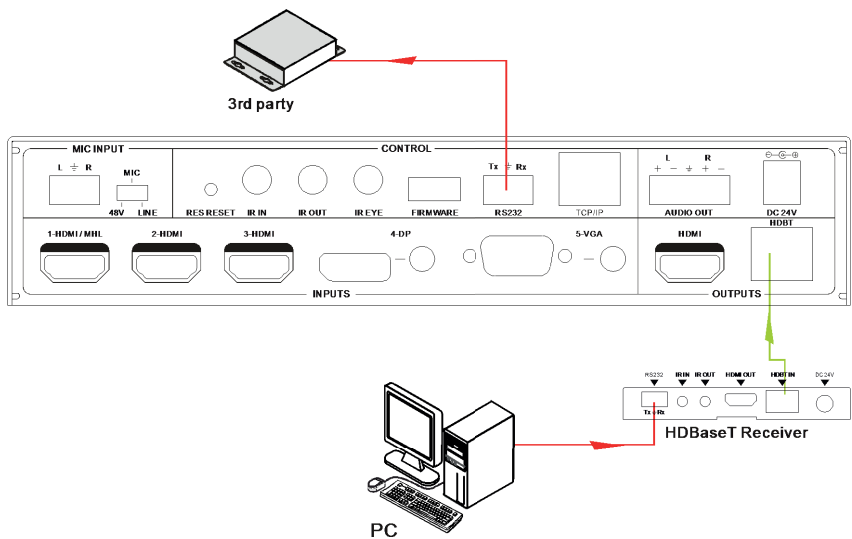







## 4.4 OSD Menu Control

The Scaler Switcher provides a powerful OSD operation menu, contains 3 parts: optional settings, image settings, and system setting etc.

Press MENU button  on IR remote or send command 50616% to enter in OSD menu.

Operation method:

- Press , , ,  on the IR remote to switch between menu options and menu pages.
- Press  on the IR remote to confirm the selection.
- Press  on the IR remote to exit OSD menu.

### 4.4.1 OPTIONS

Includes Output Adjust, Input 5 Select, Baud rate, User EDID Load (USB), Resolution, and Software Update (USB).

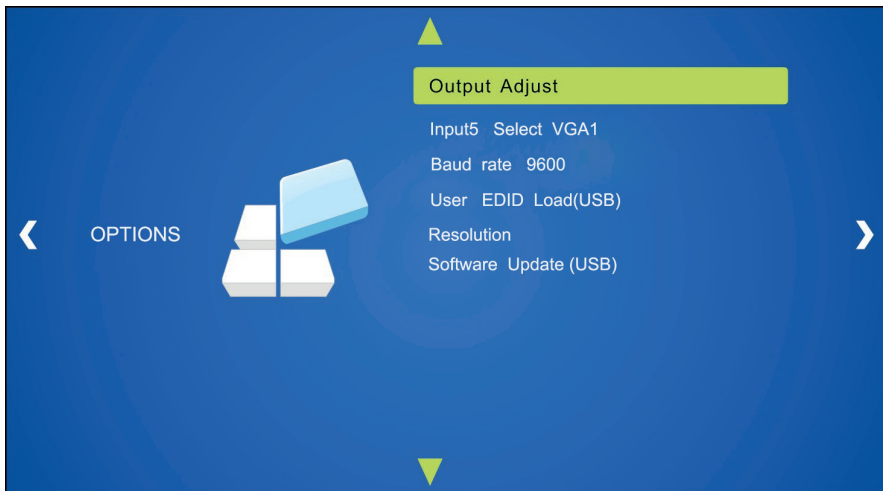

**Output Adjust:** Adjust output image position (X: horizontal direction and Y: vertical direction), aspect ratio (width and height), polarity adjustment (H Polarity and V Polarity) and output setting (HDMI on/off and HDBT on/off).

**Input5 Select:** Select video source format for VGA input, includes AV 1 (C-video signal), VGA 1 (VGA signal) and YPbPr 1 (Component video signal).

**Baud rate:** Set the baud rate for RS232 control, and it support 2400, 4800, 9600, 19200, 38400, 57600, 115200.

**User EDID Load (USB):** Insert the USB flash disk with EDID file to FIRMWARE port to load EDID data through this menu.

**RESOLUTION:** Set the output resolutions - 1920x1200, 1920x1080, 1600x1200, 1600x900, 1360x768, 1280x800, 1280x720, 1024x768.

**Software Update (USB):** Insert the USB flash disk with updating file to USB port of the Scaler Switcher, to update the software through this menu.

## 4.4.2 PICTURE

Including Picture Mode, Color Temperature, Aspect Ratio, Noise Reduction, Screen and Color Range.

Please check the picture below:

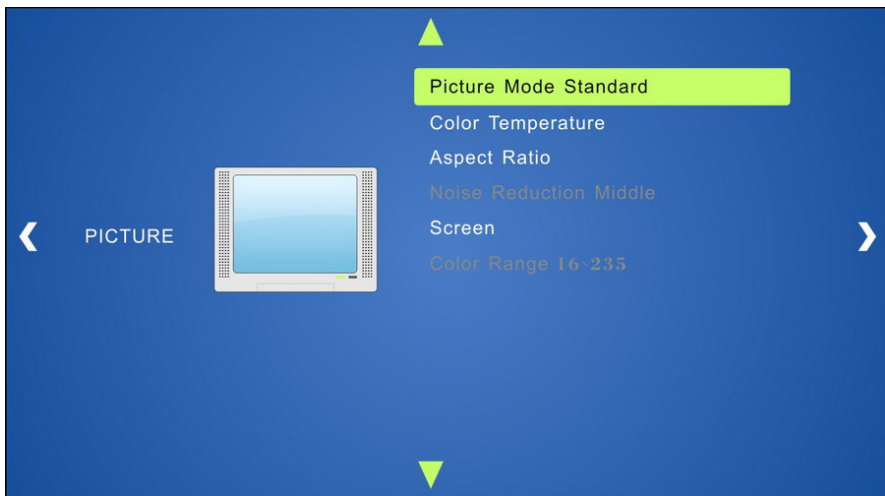

- **Picture mode:** Includes Dynamic, Standard, Mild, and User. Only in User mode, will it be able to set the image contrast, brightness, color and sharpness.
- **Color Temperature:** Includes Cool, Medium, Warm and User. And only in User mode, it is able to set values for Red, Green and Blue (RGB).
- **Aspect Ratio:** Includes Native, 4:3, 16:9, Zoom1, Zoom2, Just Scan, and Panorama. VGA format only supports 4:3, 16:9 and Panorama.
- **Noise Reduction (not for VGA format):** Includes Off, Low, Middle, High and Default.
- **Screen:** (not for HDMI source): Includes Auto Adjust, Horizontal, Vertical, Size, and Phase.
- **Color Range (not for HDMI format):** 16~235 or 0~255.

### 4.4.3 SETUP

Including OSD Language, Restore Factory Default, Blending, HDMI CEC, OSD Duration and version inquiry

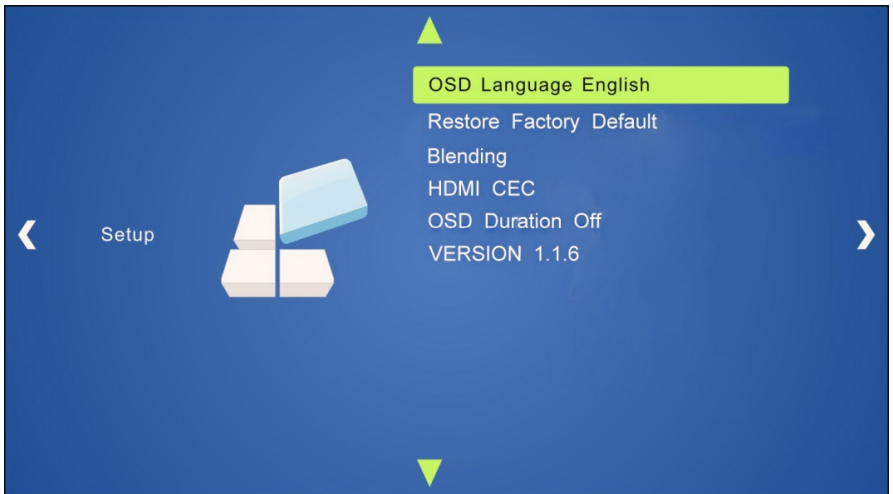

- **OSD Language:** Supports 7 languages, including English (default), Chinese etc.
- **Restore Factory Default:** Restores to original system state
- **Blending:** Includes Low, Middle, High and Off.
- **HDMI CEC:** Enable/disable CEC and auto-standby function. Default: CEC on, STANDBY on. Only when CEC is on, will it be able to set auto-standby status.
- **OSD Duration:** Includes 5 Sec, 10 Sec, 15 Sec and Off.
- **VERSION:** Displays software version

## 4.5 Web-based GUI Control

To control the Scaler Switcher,, you can use the front panel buttons, IR remote and/or RS232 communication software. The Scaler Switcher can be controlled via web-based GUI. It allows users to interact with the Scaler Switcher through graphical icons and visual indicators.

Type the local IP address of the Scaler Switcher (pre-configured: **192.168.0.178**) in your browser, it will enter the log-in interface shown as below:

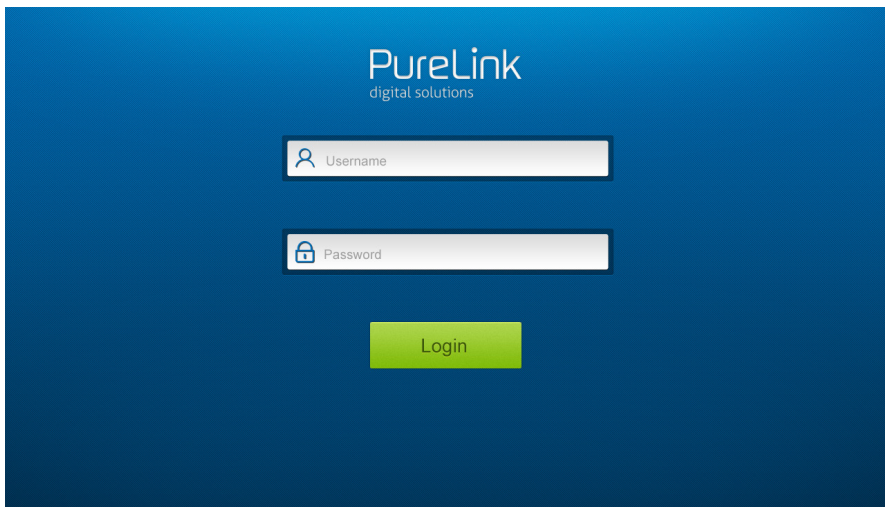



## 4.5.1 Control Menu

Type user name: user and password: user (default setting) on the log-in interface, and then click Login to enter Control menu shown as below:



- **Sources:** Click the corresponding button (1-HDMI/MHL, 2-HDMI, 3-HDMI, 4-DP, and 5-VGA) to select video input source.
- **VGA:** Click Adjust to adjust the position of VGA video output image to make sure the best visual effect.
- **DP:** Click Audio to turn on/off the DP external audio input.
- **Volume:** Click the corresponding positive/negative button to increase/decrease the volume of microphone audio or source audio input. Click the corresponding Mute button to mute/unmute microphone audio or source audio input.
- Click **Source** to turn on/off input source device.
- Click **Display** to turn on/off output display device.
- Click **Local** to let the Scaler Switcher into standby mode.

## 4.5.2 Configuration Menu

1. Click  on control menu to enter setting menu shown as below:

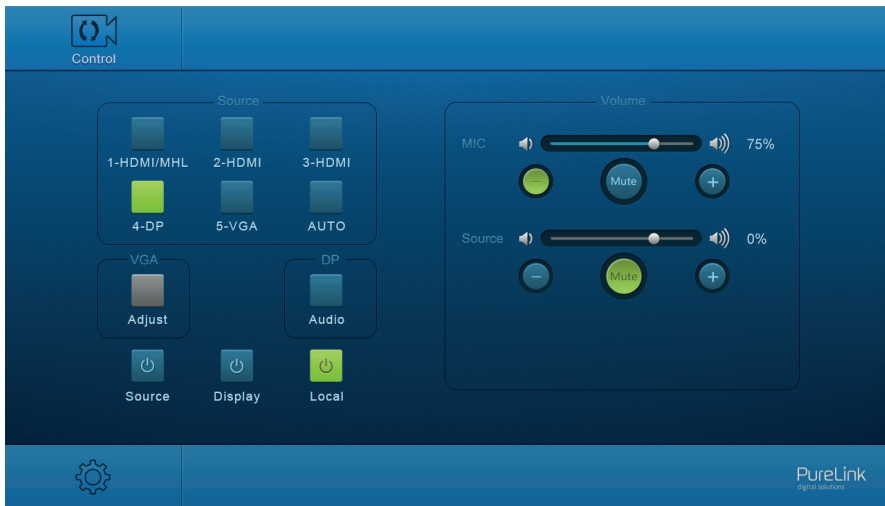

- **Output Resolution:** Select the output resolution that you need and then click Confirm.
- **Update:** Insert the USB flash disk with EDID file/software updating file to FIRMWARE port, and then click EDID/Firmware to start update procedure.
- **Shutdown Timer(NO Input):** Set the shutdown time under manual-switching mode or auto-switching mode, including none, 1 minute, 2minutes, 5minutes and 10 Minutes. If the Scaler Switcher can't detect video source input, it will automatically shut down after a preset interval.

2. Click Network to enter network setting menu shown as below:

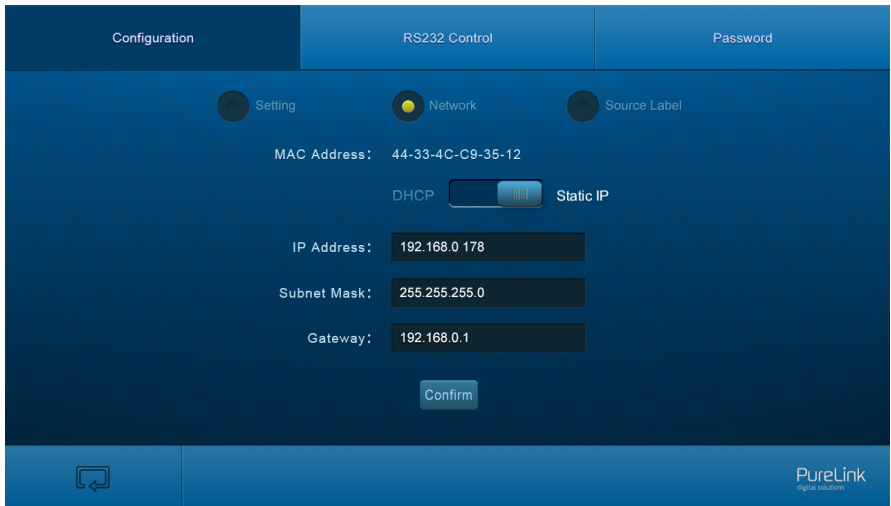

In this interface, dynamic or static IP mode can be selected. Under static IP mode, IP address and subnet mask, gateway can be set and make sure the IP addresses are different to avoid IP conflict.

3. Click Source Label to enter source label setting menu shown as below:



In this interface, the name of source input selection button can be modified as you need.

### 4.5.3 RS232 Control Menu

Click **RS232 Control** on the top of interface to enter RS232 control menu shown as below:

Configuration      RS232 Control      Password

Port: Local

Baud Rate: 2400

Command: xxxx      Hex

Send

PureLink  
digital solutions

- **Port:** Local port refers to the RS232 port of the Scaler Switcher, and the HDBT port refers to the RS232 port of HDBaseT Receiver.
- **Baud Rate:** The baud rate of local port is 9600 which can't be modified, but for HDBT port, it support 2400, 4800, 9600, 19200, 38400, 57600, 115200.
- **Command:** Typing commands in this box to control the Scaler Switcher or the far-end device which is connected to HDBaseT Receiver. If checked the "Hex", you can enter hexadecimal value in the "Command" box.

## 4.5.4 Password Menu

Click Password on the top of interface to enter password menu shown as below:

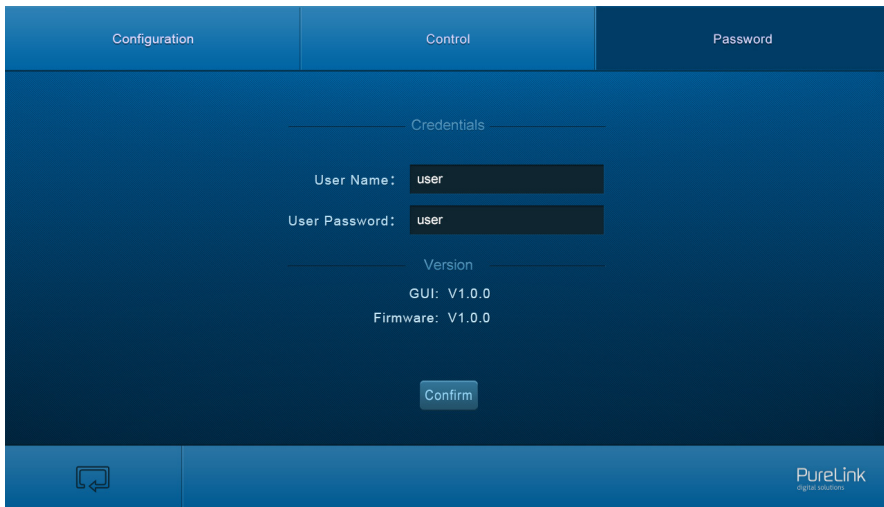

The screenshot shows the 'Password' menu in the PureLink interface. At the top, there are three tabs: 'Configuration', 'Control', and 'Password'. The 'Password' tab is selected. Below the tabs, the 'Credentials' section contains two input fields: 'User Name' with the value 'user' and 'User Password' with the value 'user'. Below this, the 'Version' section displays 'GUI: V1.0.0' and 'Firmware: V1.0.0'. A 'Confirm' button is located at the bottom center of the form. The bottom of the interface features a navigation bar with a back arrow icon on the left and the 'PureLink digital solutions' logo on the right.

In this interface, the user name and password can be modified as you need.

### 4.5.5 Web-based GUI Update

Web-based GUI for the Scaler Switcher supports online updates via the local IP address (standard: <http://192.168.0.178:100>). Type the username and password (the same as the GUI log-in settings, modified password will be available only after rebooting) to log in the configuration interface. After that, click **Administration** at the source menu to get to **Upload Program** as shown below:

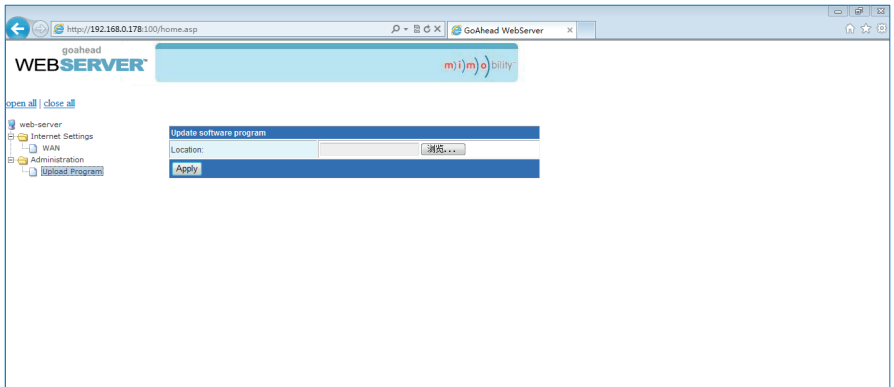

Figure 4- 19 GUI Update

Select the desired update file and press Apply, it will start upgrading then.

## 5. Specification

Video	
Video input	1 HDMI/MHL; 2 HDMI; 1 DP; 1 VGA
Video Input Connector	3 female HDMI; 1 DisplayPort; 1 female VGA (15-pin)
Input Video Signal	HDMI, DP, YPbPr, C-video, VGA
Video Output	1 HDMI; 1 HDBaseT
Video Output Connector	1 female HDMI; 1 RJ45
Output Video Signal	HDMI, HDBaseT
Output Resolution	1920x1200, 1920x1080, 1600x1200, 1600x900, 1360x768, 1280x800, 1280x720, 1024x768.
Standards	Compliant with HDMI 1.4 & HDCP2.2
Audio	
Audio Input	1 stereo audio input for DP 1 stereo audio input for VGA 1 Microphone audio
Audio Input Connector	2 3.5mm Stereo jacks 1 3-Pin phoenix connector
Audio Input Impedance	>10k $\Omega$
Audio Output	1 Dual-Mono analog audio
Audio Output Connector	1 5-Pin phoenix connector
Audio Output Impedance	70 $\Omega$
Frequency Response	20Hz-20K Hz
Stereo Channel Separation	>80dB @1KHz



<b>Control Part</b>	
Control port	1 IR IN, 1 IR OUT, 1 IR EYE, 1 RS232, 1 TCP/IP
Control Connector	3 3.5mm mini jack; 1 3-Pin phoenix connectors; 1 RJ45
<b>General</b>	
Transmission Distance	1080P≤70m(Cat6)
Temperature	0 ~ +50°C
Humidity	10% ~ 90%
Power Supply	DC24V 2.71A
Power Consumption	27W
Dimension (W*H*D)	220mm x 44mm x 172.5mm
Weight	800g



## 7. Troubleshooting & Maintenance

Problems	Causes	Solutions
Output image with snowflake	Bad quality of the connecting cable	Try another high quality cable.
	Fail or loose connection	Make sure the connection is good
No output image when switching	No signal at the input / output end	Check with oscilloscope or multimeter if there is any signal at the input/output end.
	Fail or loose connection	Make sure the connection is good
	The switcher is broken	Send it to authorized dealer for repairing.
POWER indicator doesn't work or no respond to any operation	Fail connection of power cord.	Make sure the power cord connection is good.
EDID management does not work normally	The HDMI cable is broken at the output end.	Change for another HDMI cable which is in good working condition.
Static becomes stronger when connecting the video connectors	Bad grounding	Check the grounding and make sure it is connected well.
Cannot control the device by control device (e.g. a PC) through RS232 port	Wrong RS232 communication parameters	Type in correct RS232 communication parameters.
	Broken RS232 port	Send it to authorized dealer for checking.

---

Cannot control the device by front panel buttons while can control it through RS232 port	The front panel buttons are locked	Send command 50605% to unlock the front panel buttons.
Cannot control the device by RS232 / IR remote / front panel buttons	The device has already been broken.	Send it to authorized dealer for repairing.

If your problem persists after following the above troubleshooting steps, seek further help from authorized dealer or our technical support.

## 8. After-sales Service

If there appear some problems when running the Scaler Switcher, please check and deal with the problems referring to this user manual. Any transport costs are borne by the users during the warranty.

- 1) Product Limited Warranty:** We warrants that its products will be free from defects in materials and workmanship for three years, which starts from the first day you buy this product (The purchase invoice shall prevail). Proof of purchase in the form of a bill of sale or receipted invoice which is evidence that the unit is within the Warranty period must be presented to obtain warranty service.

**2) What the warranty does not cover:**

- Warranty expiration.
- Factory applied serial number has been altered or removed from the product.
- Damage, deterioration or malfunction caused by:
  - Normal wear and tear
  - Use of supplies or parts not meeting our specifications
  - No certificate or invoice as the proof of warranty.
  - The product model showed on the warranty card does not match with the model of the product for repairing or had been altered.
  - Damage caused by force majeure.
  - Servicing not authorized.
  - Any other causes which does not relate to a product defect
- Delivery, installation or labor charges for installation or setup of the product

**3) Technical Support:** For any questions or problems, contact your distributor or reseller and tell them the respective product name and version, the detailed failure situation as well as the formation of the cases.

---

## Asking for Assistance

**Technical Support:**

Phone: +49 5971 800299 - 0

Fax: +49 5971 800299 - 99

**Technical Support Hours:**

8:30 AM to 5:00 PM Monday - Thursday

8:30 AM to 4:00 PM Friday

**Write To:**

PureLink GmbH

Von-Liebig-Straße 10

D - 48432 Rheine

[www.purelink.de](http://www.purelink.de)

[info@purelink.de](mailto:info@purelink.de)