



BenQ.com

© 2015 BenQ Corporation.
All rights reserved. Rights of modification reserved.

P/N: 4JJD01.001



PX9510 / PW9520 / PU9530

Digital Projector

Quick Start Guide

Kurzanleitung

Guía de inicio rápido

Guide de démarrage rapide

Guida rapida

Snabbstartsguide

Guia de iniciação rápida

Краткое руководство

快速使用指南

빠른 시작 안내서

クイックスタートガイド

快速使用指南

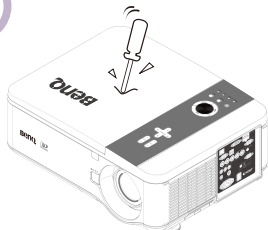
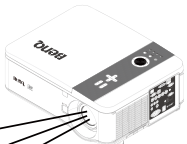
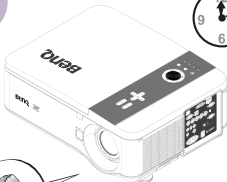
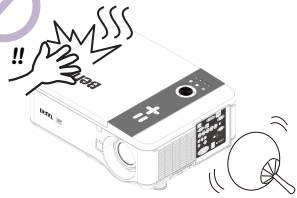
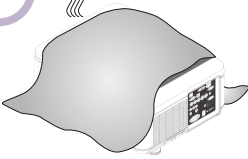
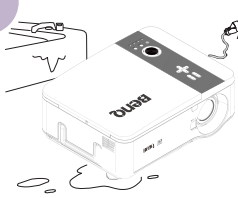
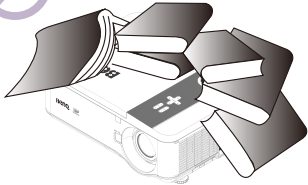
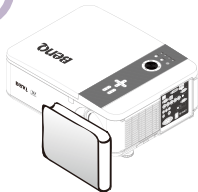
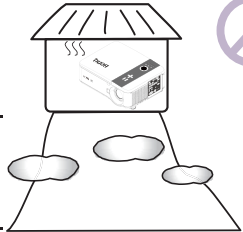
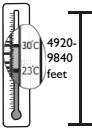
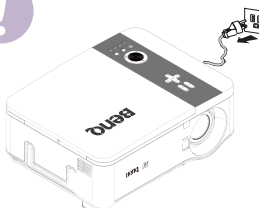
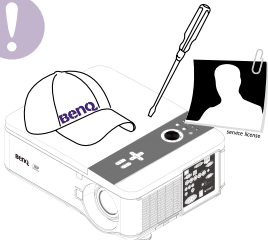
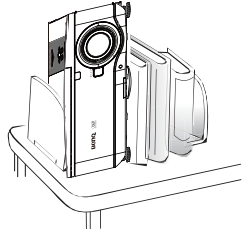
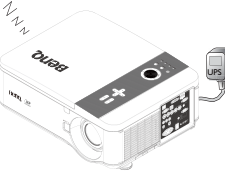
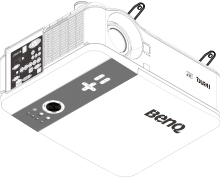
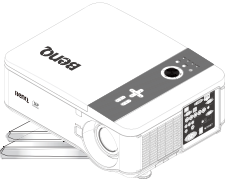
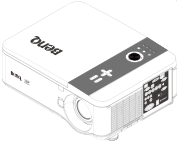



Projector
without lens



Remote
Without AA batteries



Warranty card

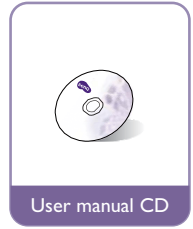

User manual CD



Quick start guide

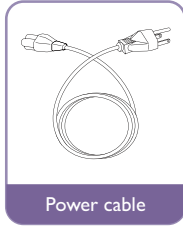

Power cable

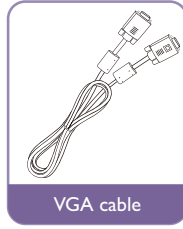

VGA cable



6S-Type Color wheel

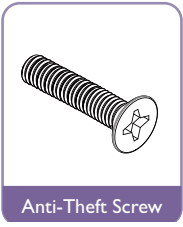

Anti-Theft Screw



Wired Remote cable



Lens Hole Cap

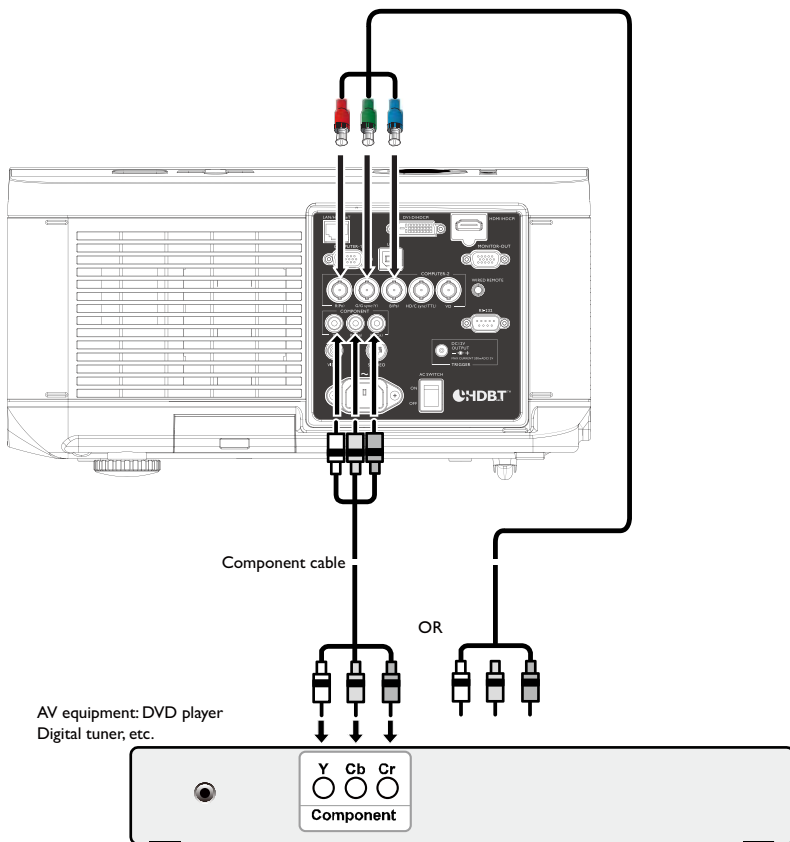
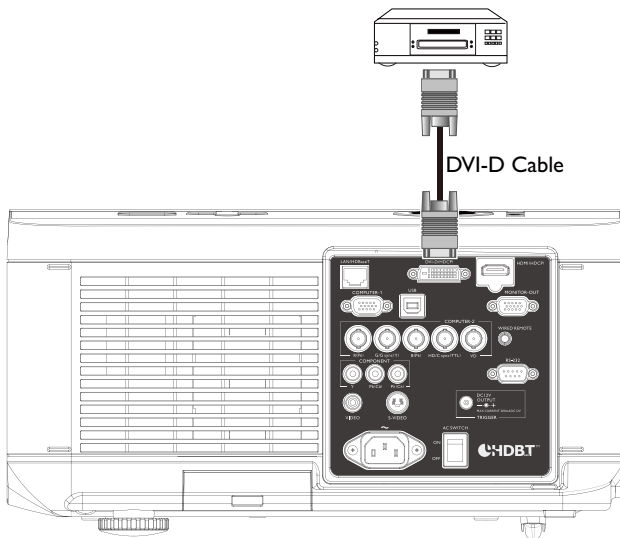

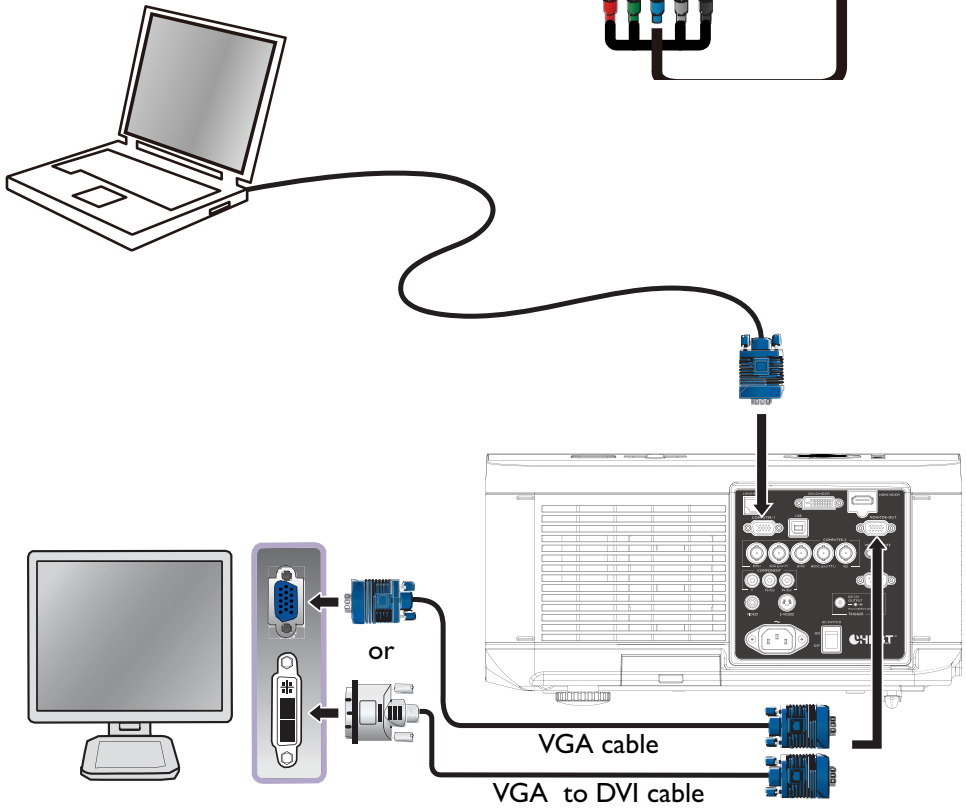
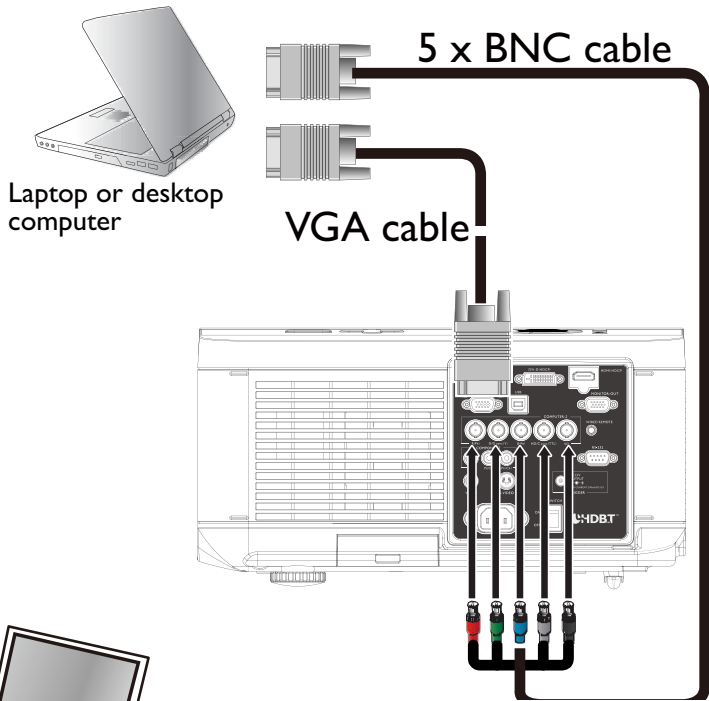

Ceiling Mount Installation

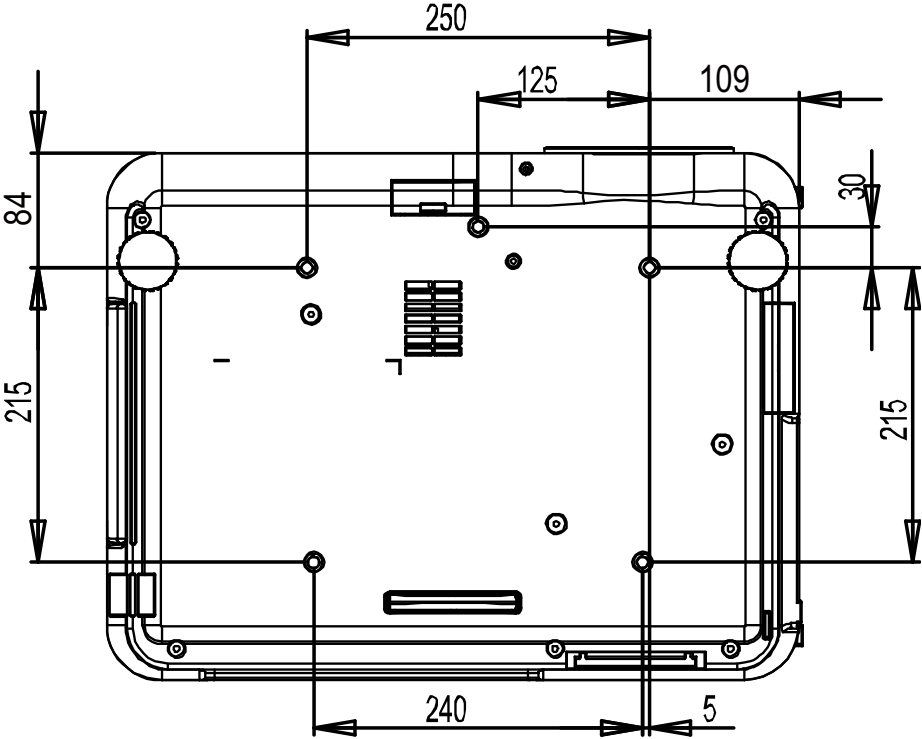

(Mounting Screw: M4*12mm)

Projection dimensions

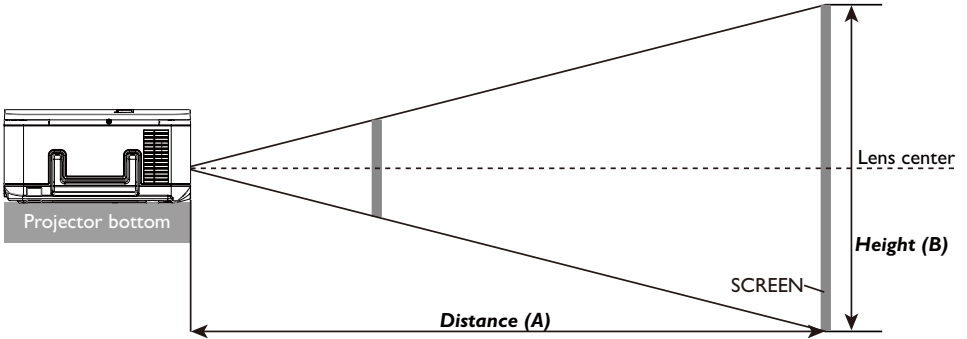

PU9530

Screen Size						5JJAM37.011		5JJAM37.021				5JJAM37.001				5JJAM37.051							
						Wide Fix Lens		Wide Zoom Lens				Standard Lens				Semi long Zoom I							
Diagonal		Width		Height(B)		Distance(A)																	
						N/A		Wide		Tele		Wide		Tele		Wide		Tele					
(inch)	(m)	(inch)	(m)	(inch)	(m)	(inch)	(m)	(inch)	(m)	(inch)	(m)	(inch)	(m)	(inch)	(m)	(inch)	(m)	(inch)	(m)				
40	1.02	34	0.86	21	0.54	25.1	0.64	41.4	1.05	59.9	1.52	57.2	1.45	75.8	1.93	73.6	1.87	124.1	3.15				
50	1.27	42	1.08	26	0.67	31.8	0.81	52.3	1.33	75.4	1.92	72.1	1.83	95.5	2.42	92.9	2.36	155.9	3.96				
60	1.52	51	1.29	32	0.81	38.5	0.98	63.1	1.60	90.9	2.31	87.1	2.21	115.1	2.92	112.1	2.85	187.8	4.77				
80	2.03	68	1.72	42	1.08	52.0	1.32	84.9	2.16	121.8	3.09	117.0	2.97	154.3	3.92	150.5	3.82	251.4	6.39				
100	2.54	85	2.15	53	1.35	65.5	1.66	106.6	2.71	152.7	3.88	147.0	3.73	193.5	4.92	188.9	4.80	315.0	8.00				
120	3.05	102	2.58	64	1.62	78.9	2.01	128.4	3.26	183.6	4.66	176.9	4.49	232.8	5.91	227.6	5.78	378.6	9.62				
150	3.81	127	3.23	79	2.02	99.1	2.52	161.0	4.09	230.0	5.84	221.8	5.63	291.6	7.41	285.0	7.24	474.1	12.04				
180	4.57	153	3.88	95	2.42	119.3	3.03	193.6	4.92	276.4	7.02	266.7	6.77	350.5	8.90	342.6	8.70	569.5	14.47				
200	5.08	170	4.31	106	2.69	132.8	3.37	215.3	5.47	307.3	7.81	296.6	7.53	389.7	9.90	381.0	9.68	633.1	16.08				
300	7.62	254	6.46	159	4.04	200.1	5.08	324.0	8.23	461.9	11.73	446.3	11.34	585.9	14.9	573.2	14.56	951.2	24.16				
400	10.16	339	8.62	212	5.38	267.4	6.79	432.7	10.99	616.6	15.66	595.9	15.14	782.3	19.87	765.3	19.44	1269.7	32.25				
500	12.70	424	10.77	265	6.73	334.8	8.50	541.5	13.75	771.2	19.59	745.6	18.94	978.3	24.85	957.4	24.32	1587.8	40.33				

Screen Size						5JJAM37.031				5JJAM37.041				5JJAM37.061			
						Long Zoom 1 Lens				Long zoom 2 Lens				Ultra Wide zoom Lens			
Diagonal		Width		Height(B)		Distance(A)											
						Wide		Tele		Wide		Tele		Wide		Tele	
(inch)	(m)	(inch)	(m)	(inch)	(m)	(inch)	(m)	(inch)	(m)	(inch)	(m)	(inch)	(m)	(inch)	(m)	(inch)	(m)
40	1.02	34	0.86	21	0.54	118.7	3.01	181.0	4.60	173.9	4.42	277.7	7.05	24.5	0.62	31.1	0.79
50	1.27	42	1.08	26	0.67	149.7	3.80	227.6	5.78	220.2	5.59	350.0	8.89	31.1	0.79	39.2	1.00
60	1.52	51	1.29	32	0.81	180.7	4.59	274.1	6.96	266.6	6.77	422.3	10.73	37.6	0.96	47.4	1.20
80	2.03	68	1.72	42	1.08	242.7	6.16	367.3	9.33	359.4	9.13	567.0	14.40	50.8	1.29	63.8	1.62
100	2.54	85	2.15	53	1.35	304.3	7.73	460.4	11.70	452.1	11.48	711.6	18.07	63.9	1.62	80.2	2.04
120	3.05	102	2.58	64	1.62	366.7	9.31	553.6	14.06	544.9	13.84	856.2	21.75	77.1	1.96	96.6	2.45
150	3.81	127	3.23	79	2.02	459.4	11.67	693.3	17.61	684.0	17.37	1073.1	27.26	96.8	2.46	121.1	3.08
180	4.57	153	3.88	95	2.42	552.4	14.03	833.0	21.16	823.1	20.91	1290.1	32.77	116.5	2.96	145.7	3.70
200	5.08	170	4.31	106	2.69	614.7	15.6	926.4	23.53	915.9	23.26	1434.7	36.44	129.7	3.29	162.1	4.12
300	7.62	254	6.46	159	4.04	924.0	23.47	1392.1	35.36	1379.6	35.04	2157.8	54.81	195.4	4.96	244.0	6.20
400	10.16	339	8.62	212	5.38	1233.9	31.34	1857.9	47.19	1843.3	46.82	2880.9	73.18	261.2	6.63	325.9	8.28
500	12.70	424	10.77	265	6.73	1543.7	39.21	2323.6	59.02	2307.1	58.60	3604.0	91.54	326.9	8.30	407.7	10.36

PW9520

Screen Size						5JJAM37.01I		5JJAM37.02I				5JJAM37.00I				5JJAM37.05I			
						Wide Fix Lens		Wide Zoom Lens				Standard Lens				Semi long Zoom I			
Diagonal		Width		Height(B)		Distance(A)													
						N/A		Wide		Tele		Wide		Tele		Wide		Tele	
(inch)	(m)	(inch)	(m)	(inch)	(m)	(inch)	(m)	(inch)	(m)	(inch)	(m)	(inch)	(m)	(inch)	(m)	(inch)	(m)	(inch)	(m)
40	1.02	34	0.86	21	0.54	26.4	0.67	43.6	1.11	63.1	1.60	60.2	1.53	79.8	2.03	77.6	1.97	130.5	3.31
50	1.27	42	1.08	26	0.67	33.5	0.85	55.0	1.40	79.3	2.01	75.9	1.93	100.4	2.55	97.8	2.48	163.9	4.16
60	1.52	51	1.29	32	0.81	40.5	1.03	66.4	1.69	95.5	2.43	91.7	2.33	121.0	3.07	117.9	3.00	197.3	5.01
80	2.03	68	1.72	42	1.08	54.7	1.39	89.3	2.27	128.0	3.25	123.1	3.13	162.3	4.12	158.3	4.02	264.1	6.71
100	2.54	85	2.15	53	1.35	68.8	1.75	112.1	2.85	160.5	4.08	154.5	3.93	203.5	5.17	198.7	5.05	330.9	8.41
120	3.05	102	2.58	64	1.62	82.9	2.11	135.0	3.43	193.0	4.90	186.0	4.72	244.7	6.22	239.0	6.07	397.7	10.10
150	3.81	127	3.23	79	2.02	104.1	2.64	169.2	4.30	241.7	6.14	233.1	5.92	306.5	7.79	299.6	7.61	498.0	12.65
180	4.57	153	3.88	95	2.42	125.3	3.18	203.5	5.17	290.4	7.38	280.3	7.12	368.4	9.36	360.1	9.15	598.2	15.19
200	5.08	170	4.31	106	2.69	139.4	3.54	226.4	5.75	322.9	8.20	311.7	7.92	409.6	10.40	400.5	10.17	665.0	16.89
300	7.62	254	6.46	159	4.04	210.0	5.33	340.6	8.65	485.3	12.33	468.9	11.91	615.7	15.64	602.3	15.30	999.0	25.38
400	10.16	339	8.62	212	5.38	280.6	7.13	454.8	11.55	647.7	16.45	626.1	15.90	821.9	20.88	804.1	20.42	1333.1	33.86
500	12.70	424	10.77	265	6.73	351.2	8.92	569.0	14.45	810.1	20.58	783.3	19.90	1028.0	26.11	1005.9	25.55	1667.1	42.35

Screen Size						5JJAM37.03I				5JJAM37.04I				5JJAM37.06I			
						Long Zoom I Lens				Long zoom 2 Lens				Ultra Wide zoom Lens			
Diagonal		Width		Height(B)		Distance(A)											
						Wide		Tele		Wide		Tele		Wide		Tele	
(inch)	(m)	(inch)	(m)	(inch)	(m)	(inch)	(m)	(inch)	(m)	(inch)	(m)	(inch)	(m)	(inch)	(m)	(inch)	(m)
40	1.02	34	0.86	21	0.54	124.9	3.17	190.3	4.83	183.3	4.65	292.2	7.42	25.8	0.65	32.8	0.83
50	1.27	42	1.08	26	0.67	157.5	4.00	239.2	6.08	232.0	5.89	368.1	9.35	32.7	0.83	41.4	1.05
60	1.52	51	1.29	32	0.81	190.1	4.83	288.1	7.32	280.7	7.13	444.0	11.28	39.6	1.00	50.0	1.27
80	2.03	68	1.72	42	1.08	255.2	6.48	385.9	9.80	378.1	9.60	595.9	15.13	53.3	1.35	67.3	1.71
100	2.54	85	2.15	53	1.35	320.3	8.14	483.7	12.29	475.6	12.08	747.7	18.99	67.1	1.70	84.5	2.15
120	3.05	102	2.58	64	1.62	385.5	9.79	581.5	14.77	573.0	14.55	899.6	22.85	80.9	2.05	101.8	2.59
150	3.81	127	3.23	79	2.02	483.2	12.27	728.2	18.50	719.1	18.27	1127.3	28.63	101.6	2.58	127.6	3.24
180	4.57	153	3.88	95	2.42	580.9	14.75	874.9	22.22	865.3	21.98	1355.1	34.42	122.2	3.10	153.5	3.90
200	5.08	170	4.31	106	2.69	646.0	16.41	972.7	24.71	962.7	24.45	1506.9	38.28	136.0	3.45	170.8	4.34
300	7.62	254	6.46	159	4.04	971.7	24.68	1461.8	37.13	1449.9	36.83	2266.2	57.56	204.9	5.20	257.0	6.53
400	10.16	339	8.62	212	5.38	1297.3	32.95	1950.8	49.55	1937.1	49.20	3025.4	76.85	273.8	6.95	343.2	8.72
500	12.70	424	10.77	265	6.73	1623.0	41.22	2439.8	61.97	2424.2	61.58	3784.7	96.13	342.7	8.70	429.4	10.91

PX9510

Screen Size						5JJAM37.01 I			5JJAM37.02 I			5JJAM37.00 I			5JJAM37.05 I				
Diagonal						Wide Fix Lens			Wide Zoom Lens			Standard Lens			Semi long Zoom I				
Width		Height(B)		Distance(A)															
				N/A		Wide		Tele		Wide		Tele		Wide		Tele			
(inch)	(m)	(inch)	(m)	(inch)	(m)	(inch)	(m)	(inch)	(m)	(inch)	(m)	(inch)	(m)	(inch)	(m)	(inch)	(m)		
40	1.02	32	0.81	24	0.61	24.5	0.62	40.4	1.03	58.5	1.49	55.8	1.42	74.1	1.88	71.9	1.83	121.3	3.08
50	1.27	40	1.02	30	0.76	31.0	0.79	51.0	1.30	73.6	1.87	70.4	1.79	93.2	2.37	90.7	2.30	152.4	3.87
60	1.52	48	1.22	36	0.91	37.6	0.96	61.6	1.57	88.8	2.25	85.1	2.16	112.4	2.86	109.5	2.78	183.5	4.66
80	2.03	64	1.63	48	1.22	50.8	1.29	82.9	2.11	119.0	3.02	114.3	2.90	150.8	3.83	147.0	3.73	245.7	6.24
100	2.54	80	2.03	60	1.52	63.9	1.62	104.1	2.65	149.2	3.79	143.5	3.65	189.1	4.80	184.6	4.69	307.9	7.82
120	3.05	96	2.44	72	1.83	77.1	1.96	125.4	3.18	179.4	4.56	172.8	4.39	227.4	5.78	222.1	5.64	370.1	9.40
150	3.81	120	3.05	90	2.29	96.8	2.46	157.3	3.99	224.8	5.71	216.7	5.50	285.0	7.24	278.4	7.07	463.4	11.77
180	4.57	144	3.66	108	2.74	116.6	2.96	189.1	4.80	270.1	6.86	260.5	6.62	342.5	8.70	334.8	8.50	556.7	14.14
200	5.08	160	4.06	120	3.05	129.7	3.30	210.4	5.34	300.3	7.63	289.8	7.36	380.8	9.67	372.3	9.46	618.9	15.72
300	7.62	240	6.1	180	4.57	195.5	4.97	316.6	8.04	451.5	11.47	436.0	11.07	572.6	14.54	560.0	14.23	930.0	23.62
400	10.16	320	8.13	240	6.1	261.3	6.64	422.9	10.74	602.6	15.31	582.2	14.79	764.3	19.41	747.8	18.99	1241.0	31.52
500	12.70	400	10.16	300	7.62	327.1	8.31	529.1	13.44	753.7	19.14	728.5	18.50	956.1	24.28	935.5	23.76	1552.0	39.42

Screen Size						5JJAM37.03 I			5JJAM37.04 I			5JJAM37.06 I					
Diagonal						Long Zoom 1 Lens			Long zoom 2 Lens			Ultra Wide zoom Lens					
Width		Height(B)		Distance(A)													
				Wide		Tele		Wide		Tele		Wide		Tele			
(inch)	(m)	(inch)	(m)	(inch)	(m)	(inch)	(m)	(inch)	(m)	(inch)	(m)	(inch)	(m)	(inch)	(m)		
40	1.02	32	0.81	24	0.61	115.9	2.94	176.8	4.49	169.6	4.31	271.2	6.89	23.9	0.61	30.4	0.77
50	1.27	40	1.02	30	0.76	146.2	3.71	222.3	5.65	215.0	5.46	341.9	8.68	30.3	0.77	38.4	0.98
60	1.52	48	1.22	36	0.91	176.5	4.48	267.9	6.80	260.3	6.61	412.6	10.48	36.7	0.93	46.5	1.18
80	2.03	64	1.63	48	1.22	237.1	6.02	358.9	9.12	350.9	8.91	554.0	14.07	49.5	1.26	62.5	1.59
100	2.54	80	2.03	60	1.52	297.7	7.56	450.0	11.43	441.6	11.22	695.3	17.66	62.4	1.58	78.6	2.00
120	3.05	96	2.44	72	1.83	358.2	9.10	541.0	13.74	532.2	13.52	836.7	21.25	75.2	1.91	94.7	2.40
150	3.81	120	3.05	90	2.29	449.1	11.41	677.6	17.21	668.2	16.97	1048.8	26.64	94.4	2.40	118.8	3.02
180	4.57	144	3.66	108	2.74	540.0	13.72	814.2	20.68	804.1	20.42	1260.9	32.03	113.7	2.89	142.9	3.63
200	5.08	160	4.06	120	3.05	600.6	15.26	905.3	22.99	894.8	22.73	1402.2	35.62	126.5	3.21	158.9	4.04
300	7.62	240	6.1	180	4.57	903.6	22.95	1360.5	34.56	1348.0	34.24	2109.1	53.57	190.7	4.84	239.2	6.08
400	10.16	320	8.13	240	6.1	1206.6	30.65	1815.8	46.12	1801.2	45.75	2816.0	71.53	254.9	6.47	319.5	8.12
500	12.70	400	10.16	300	7.62	1509.5	38.34	2271.1	57.69	2254.3	57.26	3522.9	89.48	319.1	8.10	399.9	10.16

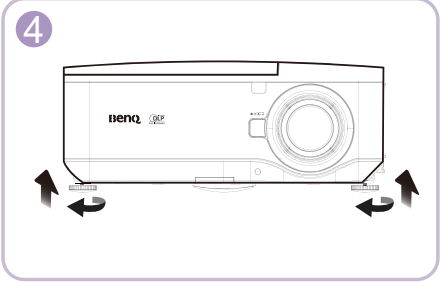
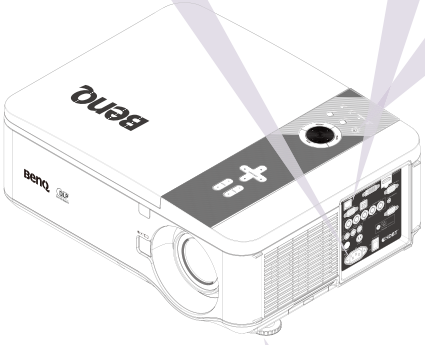
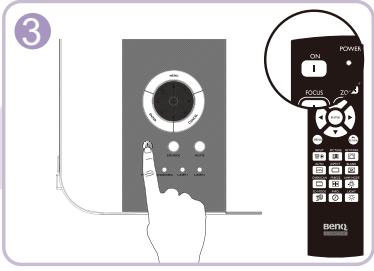
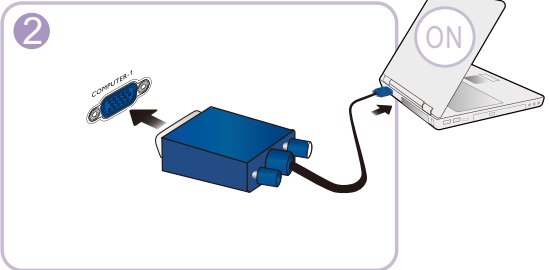
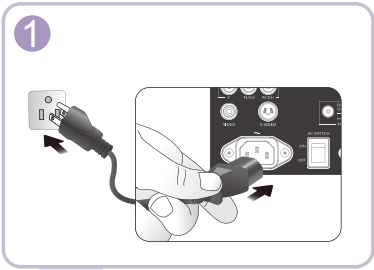

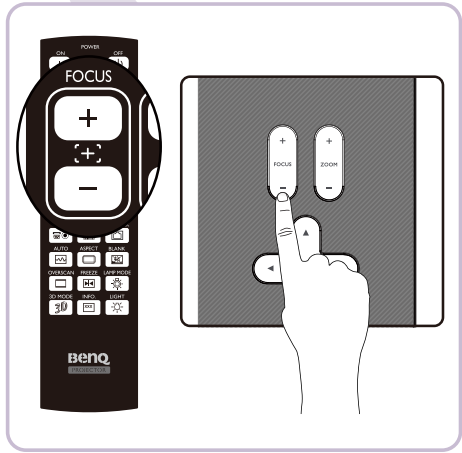
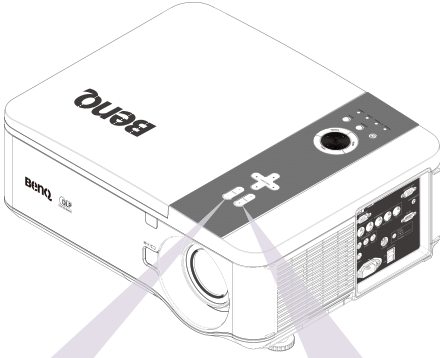
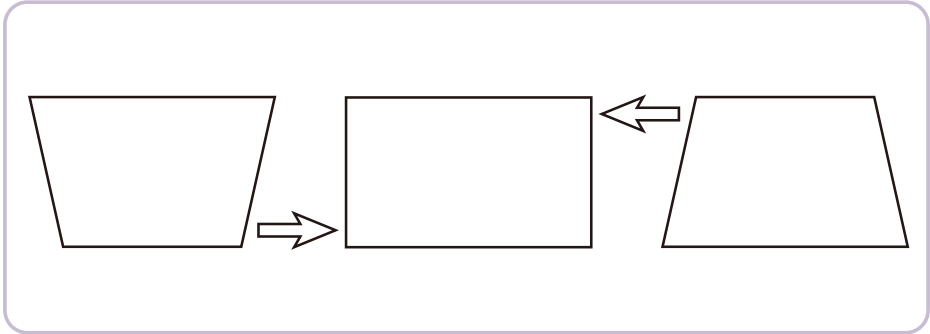

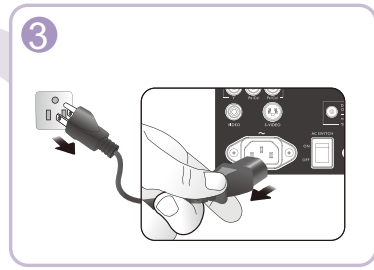
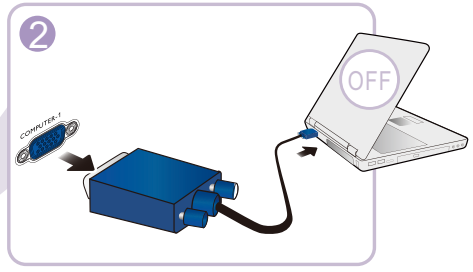
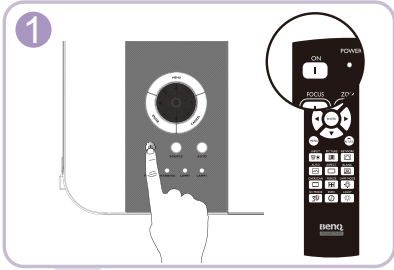
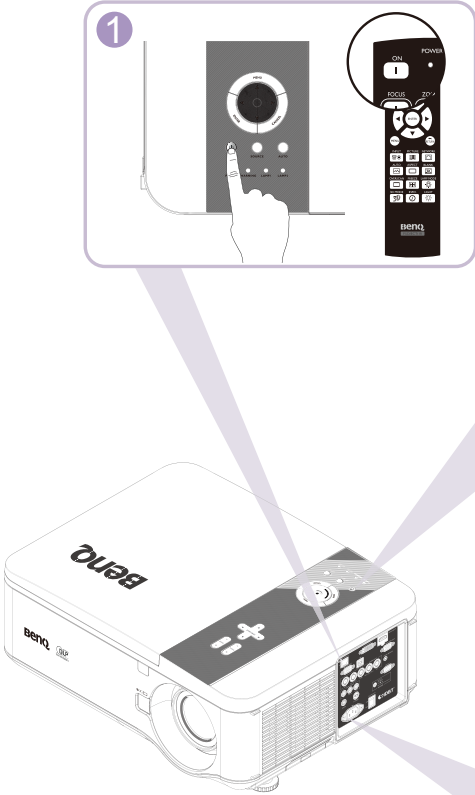

- EN For further information, please refer to the enclosed user manual.
- GM Weiter Informationen finden Sie im beiliegenden Benutzerhandbuch.
- SP Para más informaci3, consulte el manual de usuario adjunto.
- FR Pour plus d'informations, veuillez consulter le manuel d'utilistion fourni.
- IT Per ulteriori informazioni, consultare il manuale utente in dotazione.
- SW Se den medf3ljande anv3ndarhandboken f3r mer information.
- PR Para mais informa33es, consulte o manual do utilizador fornecido.
- RU Дoпoлнитeльные сведения см. в прилагаeмом руководстве пользователя.
- SC 要了解更多信息，请参见所付的用户手册。
- KR 자세한 내용은 동봉된 사용 설명서를 참조하십시오.
- JP 詳細は、付属のユーザー マニュアルを参照ください。
- TC 如需詳細資訊，請參閱附件的使用手冊。

Table of contents

English	14
Deutsch	15
Español	16
Français I	17
Italiano.....	18
Svenska.....	19
Português	20
Русский	21
简体中文.....	22
한국의	23
日本語	24
繁體中文.....	25



All specifications are subject to change without notice.

Optical

Resolution

WUXGA / WXGA / XGA

Display system

Single-chip DLP™ system

Lens F/Number

F=1.64 to 1.86, f=26.0 to 34.0 mm

Lamp

Dual 280W lamp

Electrical

Power supply

AC 100-240V, 7.30A

50/60 Hz

Power consumption

710W (max); < 0.5W (Standby)

Mechanical

Weight

17 kg / 37.5 lb

Output terminals

Monitor out

D-sub 15pin x1

Control

USB

Mini B Type

RS-232 serial control

9 pin x1

I2V TRIGGER

12VDC (Max. 0.5A) x1

Wired Remote

Phone jack x1

Input terminals

Computer input

RGB input

D-Sub 15-pin (females) x1

DVI-D x1

Video signal input

VIDEO

RCA jack x1

S-Video mini 4pin jack x1

SD/HDTV signal input

Analog-Component

HDMI x1

HDBaseT / LAN x1

RCA jack x3

BNC x5

Environmental Requirements

Operating temperature

5°C-40°C at sea level

Operating relative humidity

10%-90% (without condensation)

Operating altitude

0-1499 m at 0°C-35°C

1500-3000 m at 0°C-30°C

(with High Altitude Mode on)



Alle Daten können ohne Bekanntmachung geändert werden.

Optische Daten

Auflösung

WUXGA / WXGA / XGA

Anzeigesystem

Einzel-Chip DLP™ System

F-Wert des Objektivs

F=1,64 bis 1,86, f=26,0 bis 34,0 mm

Lampe

Dual 280 W Lampe

Elektrische Anschlusswerte

Stromversorgung

AC 100-240 V, 7,30 A

50/60 Hz

Stromverbrauch

710 W (max); < 0,5 W (Standby)

Weitere Daten

Gewicht

17 kg / 37,5 lb

Ausgänge

Monitorausgang

D-Sub 15 Pin x1

Steuerung

USB

Mini B Type

Serielle RS-232-Steuerung

9 Pin x1

12 V AUSLÖSER

12 VDC (Max 0,5 A) x1

Kabellose Fernbedienung

Telefonbuchse x1

Eingänge

Computereingang

RGB-Eingang

D-Sub 15 Pin (weiblich) x1

DVI-D x1

Videosignaleingang

VIDEO

Cinch-Buchse x1

S-Video Mini 4 Pin Buchse x1

SD/HDTV-Eingangssignal

Analog-Component

HDMI x1

HDBaseT / LAN x1

Cinch-Buchse x3

BNC x5

Umgebungsbedingungen

Betriebstemperatur

5°C-40°C auf Meereshöhe

Luftfeuchtigkeit bei Betrieb

10%-90% (nicht kondensierend)

Höhenlage bei Betrieb

0-1499 m bei 0°C-35°C

1500-3000 m bei 0°C-30°C

(mit Höhenmodus Ein)



Todas las especificaciones están sujetas a cambio sin previo aviso.

Óptico

Resolución

WUXGA / WXGA / XGA

Sistema óptico

Sistema DLP™ de un solo chip

Lente F/Número

F=1,64 a 1,86, f=26,0 a 34,0 mm

Lámpara

Lámpara de 280 W dual

Especificaciones eléctricas

Fuente de alimentación

100-240 V de CA, 7,30 A

50/60 Hz

Consumo de energía

710 W (máx); < 0,5 W

(modo de espera)

Especificaciones mecánicas

Peso

17 kg / 37,5 lb

Terminales de salida

Salida de monitor

D-sub de 15 patillas x1

Control

USB

Tipo Mini B

Control de serie RS-232

9 patillas x1

DISPARADOR DE 12 V

12 V de CC (Máx. 0,5 A) x1

Mando con cable

Clavija de auriculares x1

Terminales de entrada

Entrada de ordenador

Entrada RGB

D-Sub de 15 patillas (hembra) x1

DVI-D x1

Entrada de señal de vídeo

VIDEO

Clavija RCA x1

Miniclavija S-Video de 4 patillas x1

Entrada de señal de SD/HDTV

Analógico - Componente

HDMI x1

HDBaseT / LAN x1

Clavija RCA x3

BNC x5

Requisitos medioambientales

Temperatura de funcionamiento

5°C-40°C a nivel del mar

Humedad relativa de funcionamiento

10% - 90% (sin condensación)

Altitud de funcionamiento

0-1499 m a 0°C-35°C

1500-3000 m a 0°C-30°C

(como el Modo altitud elevada activado)



Toutes les caractéristiques peuvent être modifiées sans notification préalable.

Caractéristiques optiques

Résolution

WXGA / WXGA / XGA

Système d'affichage

Système à une puce DLP™

Ouverture (nombre F)

F=1,64 à 1,86, f=26,0 à 34,0 mm

Lampe

Double lampe 280 W

Caractéristiques électriques

Alimentation

Secteur 100-240 V, 7,30 A

50/60 Hz

Consommation

710 W (max) ; < 0,5 W (veille)

Caractéristiques mécaniques

Poids

17 kg / 37,5 lb

Prises de sortie

Sortie moniteur

1 D-Sub 15 broches

Commande

USB

Type mini B

Contrôle série RS-232

1 x 9 broches

Déclencheur 12 V

1 x 12 V CC (Max. 0,5A)

Télécommande câblée

1 prise téléphone

Prises d'entrée

Entrée ordinateur

Entrée RVB

1 D-Sub à 15 broches (femelle)

1 DVI-D

Entrée signal vidéo

VIDEO

1 prise RCA

1 Prise mini S-Vidéo à 4 broches

Entrée de signal SD/HDTV

Analogique-Composantes

1 HDMI

1 HDBaseT / LAN

3 prises RCA

5 BNC

Caractéristiques environnementales

Température de fonctionnement

5°C à 40°C au niveau de la mer

Humidité relative en fonctionnement

10% à 90% (sans condensation)

Altitude de fonctionnement

0-1499 m à 0°C-35°C

1500-3000 m à 0°C-30°C

(avec Mode Haute altitude activé)



Tutte le specifiche sono soggette a modifiche senza preavviso.

Parte ottica

Risoluzione

WUXGA / WXGA / XGA

Sistema di visualizzazione

Sistema DLP™ a chip singolo

Numero/F dell'obiettivo

F=1,64 - 1,86, f=26,0 - 34,0 mm

Lampada

Lampada doppia da 280 W

Parte elettrica

Alimentazione

CA 100-240 V, 7,30 A

50/60 Hz

Consumo energetico

710 W (max); < 0,5 W (Standby)

Parte meccanica

Peso

17 kg / 37,5 lb

Terminali output

Uscita monitor

D-sub a 15pin x1

Controllo

USB

Tipo Mini B

Controllo seriale RS-232

9 pin x1

TRIGGER 12 V

12VCC (Massimo 0,5A) x1

Controllo cablato

Jack telefono x1

Terminali di input

Input da computer

Input RGB

D-Sub da 15-pin (femmina) x1

DVI-D x1

Input da segnale video

VIDEO

Jack RCA x1

Jack mini S-Video a 4 pin x1

Input segnale SD/HDTV

Analogico-Component

HDMI x1

HDBaseT / LAN x1

Jack RCA x3

BNC x5

Requisiti ambientali

Temperatura operativa

5°C-40°C sul livello del mare

Umidità relativa operativa

10%-90% (senza condensa)

Altitudine operativa

0-1499 m a 0°C-35°C

1500-3000 m a 0°C-30°C

(con Modalità altitudine elevata)



Alla specifikationer kan ändras utan föregående meddelande.

Optik

Upplösning

WUXGA / WXGA / XGA

Visningssystem

DLP™-system

Linsens f-nummer

F=1,64 till 1,86, f=26,0 till 34,0 mm

Lampa

TVå lampor på 280 watt

EI

Strömtillförsel

AC 100-240 V, 7,30 A

50/60 Hz

Strömförbrukning

710 W (max); < 0,5 W (viloläge)

Mekanik

Vikt

17 kg / 37,5 lb

Uttag

Utgång för bildskärm

D-Sub med 15 stift x1

Kontroll

USB

Typ Mini B

RS-232-seriekontroll

9 stift x1

12 V TRIGGER

12 VDC (Max. 0,5 A) x1

Sladdansluten fjärrkontroll

Telefonjack x1

Ingångskontakter

Datoringång

RGB-ingång

D-Sub (hona) med 15 stift x1

DVI-D x1

Videosignalingång

VIDEO

RCA-jack x1

S-Video mini 4-stiftsjack x1

SD/HDTV-signalingång

Analog-Komponent

HDMI x1

HDBaseT / LAN x1

RCA-jack x3

BNC x5

Miljökrav

Driftstemperatur

5°C-40°C vid havsnivå

Relativ luftfuktighet vid drift

10%-90% (icke-kondenserande)

Driftshöjd

0-1 499 m vid 0 °C-35°C

1 500-3 000 m vid 0 °C-30°C

(med höghöjdsläge på)



Todas as especificações estão sujeitas a alteração sem aviso prévio.

Ópticas

Resolução

WUXGA / WXGA / XGA

Sistema de ecrã

Sistema DLP™ de um só chip

Número F da lente

F=1,64 a 1,86, f=26,0 a 34,0 mm

Lâmpada

Lâmpada dupla de 280 W

Eléctricas

Fonte de alimentação

AC 100-240 V, 7,30 A

50/60 Hz

Consumo de energia

710 W (máx); < 0,5 W (Em espera)

Mecânicas

Peso

17 Kg / 37,5 lb

Terminais de saída

Saída do monitor

D-sub 15 pinos x1

Controlo

USB

Tipo mini B

Controlo de série RS-232

9 pinos x1

TRIGGER de 12 V

12 VDC (Máx. 0,5 A) x1

Telecomando com cabo

Tomada do telefone x1

Terminais de entrada

Entrada para computador

Entrada RGB

D-Sub 15 pinos (fêmea) x1

DVI-D x1

Entrada de sinal vídeo

VIDEO

Tomada RCA x1

Tomada mini S-Video de 4 pinos x1

Entrada de sinal SD/HDTV

Analógico - Componente

HDMI x1

HDBaseT / LAN x1

Tomada RCA x3

BNC x5

Requisitos Ambientais

Temperatura de funcionamento

5°C-40°C ao nível do mar

Humidade de funcionamento

10%-90% (sem condensação)

Altitude de funcionamento

0-1499 m a 0°C-35°C

1500-3000 m a 0°C-30°C

(com Modo de Grande Altitude ligado)



Все характеристики могут быть изменены без уведомления.

Оптические характеристики

Разрешение

WUXGA / WXGA / XGA

Проекционная система

Одночиповая система DLP™

Объектив, фокусное расстояние

F = от 1,64 до 1,86, f = от 26,0 до 34,0 мм

Лампа

Две лампы по 280 Вт

Электрические характеристики

Источник питания

100-240 В перем. тока, 7,30 А
50/60 Гц

Энергопотребление

710 Вт (макс.); < 0,5 Вт
(в режиме ожидания)

Механические характеристики

Масса

17 кг / 37,5 фунта

Выходы

Выход монитора

15-контактный разъем
D-sub - 1 шт.

Управление

USB

Тип Mini B

Управление через

последовательный порт RS-232

9-контактный разъем - 1 шт.

ТРИГГЕР 12 В

12 В пост. тока (макс. 0,5А) - 1 шт.

Проводной пульт ДУ

Телефонное гнездо - 1 шт.

Входы

Вход компьютера

Вход RGB

15-контактный разъем

D-Sub (гнездо) - 1 шт.

DVI-D - 1 шт.

Вход видеосигнала

VIDEO

Разъем RCA - 1 шт.

4-контактный разъем S-Video

mini - 1 шт.

Вход сигнала SD/HDTV

Аналоговый-компонентный

HDMI - 1 шт.

HDBaseT / LAN - 1 шт.

Разъем RCA - 3 шт.

Разъем BNC - 5 шт.

Требования к условиям эксплуатации

Температура при работе

5°C-40°C на высоте уровня моря

Относительная влажность при работе

от 10% до 90 %

(без образования конденсата)

Высота при работе

0-1499 м при температуре

0°C-35°C

1500-3000 м при температуре

0°C-30°C

(при включенном режиме
высокогорья)



所有规格如有更改，恕不另行通知。

光学

分辨率

WUXGA / WXGA / XGA

显示系统

单芯片 DLP™ 系统

镜头 F 值

F=1.64 至 1.86、f=26.0 至 34.0 mm

灯泡

双灯 280 W 灯泡

电气

电源

AC 100-240 V, 7.30 A

50/60 Hz

功耗

710 W (最大) ; < 0.5 W (待机)

机械

重量

17 kg / 45 lb

输出端子

显示器输出

D-sub 15 针 x1

控制

USB

Type B 型

RS-232 串口控制器

9 针 x1

12 V 触发器

12 V 直流 (最大 0.5 A) x1

有线遥控

手机插孔 x1

输入

电脑输入

RGB 输入

D-Sub 15 针 (母) x1

DVI-D 输入 x1

视频信号输入

VIDEO

RCA 插口 x1

S- 视频 mini 4 针口 x1

SD / HDTV 信号输入

模拟 - 分量视频

HDMI 输入 x1

HDBaseT / LAN 输入 x1

RCA 插口 x3

BNC 输入 x5

环境要求

工作温度

海平时 5°C-40°C

工作相对湿度

10%-90% (无冷凝)

操作高度

0-1499 米 (0°C-35°C 下)

1500-3000 米 (0°C-30°C 下)

(高海拔模式开启)



모든 사양은 사전 통보 없이 변경될 수 있습니다.

광학 사양

해상도

WUXGA / WXGA / XGA

디스플레이 시스템

단일 칩 DLP™ 시스템

렌즈 F/ 번호

F=1.64 ~ 1.86, f=26.0 ~ 34.0 mm

램프

듀얼 280 W 램프

전기 사양

전원 공급 장치

AC 100-240 V, 7.30 A

50/60 Hz

소비 전력

710 W (최대); < 0.5 W (대기)

기계 사양

무게

17 kg / 37.5 lb

출력 단자

모니터 출력

D-sub 15 핀 x1

컨트롤

USB

Mini B 유형

RS-232 직렬 컨트롤

9 핀 x1

12 V 트리거

12 VDC (최대 0.5 A) x1

유선 리모컨

전화잭 x1

입력 단자

컴퓨터 입력 단자

RGB 입력 단자

D-Sub 15 핀 (암) x1

DVI-D x1

비디오 신호 입력 단자

VIDEO

RCA 잭 x1

S- 비디오 미니 4 핀 잭 x1

SD/HDTV 신호 입력 단자

아날로그 컴포넌트

HDMI x1

HDBaseT / LAN x1

RCA 잭 x3

BNC x5

환경 요건

작동 온도

5°C-40°C (해수면 기준)

작동 습도

10%-90%(비응결)

고도

0-1499 m, 0°C-35°C

1500-3000 m, 0°C-30°C

(높게 모드 켜짐)



仕様はすべて予告なしに変更されることがあります。

光学仕様

解像度

WUXGA / WXGA / XGA

ディスプレイ システム

Single-chip DLP™ システム

レンズ F/ ナンバー

F=1.64 ~ 1.86, f=26.0 ~ 34.0 mm

ランプ

デュアル 280 W ランプ

電気仕様

電源

AC 100-240 V, 7.30 A

50/60 Hz

消費電力

710 W (最大) ; < 0.5 W (スタンバイ)

機械仕様

重量

17 kg / 37.5 lb

出力端子

モニタ出力

D-sub 15 pin x1

コントロール

USB

Mini B タイプ

RS-232 シリアル コントロール

9 pin x1

12 V トリガー

12 VDC (最大 0.5 A) x1

有線リモート

電話ジャック x1

入力端子

コンピュータ入力

RGB 入力

D-sub 15-pin (メス) x1

DVI-D x1

ビデオ信号入力

VIDEO

RCA ジャック x1

S-Video mini 4 pin ジャック x1

SD/HDTV 信号入力

アナログ - コンポーネント

HDMI x1

HDBaseT / LAN x1

RCA ジャック x3

BNC x5

環境要件

動作温度範囲

5°C-40°C (海拔)

動作相対湿度

10% ~ 90% (結露なきこと)

動作高度

0-1499 m (0°C ~ 35°C)

1500-3000 m (0°C ~ 30°C)

(高地モード オン)



所有規格如有更改，恕不另行通知。

光學

解析度

WUXGA / WXGA / XGA

顯示系統

單片式 DLP™ 系統

鏡頭 F 值

F=1.64 至 1.86、f=26.0 至 34.0 mm

燈泡

雙燈 280 瓦雙燈泡

電子

電源

AC 100-240V、7.30A

50/60 Hz

消耗功率

710 W (最大) ; < 0.5 瓦 (待機)

機械

重量

17 公斤 / 37.5 磅

輸出端子

顯示器輸出

D-sub 15 針腳 x1

控制

USB

Type B 類型

RS-232 序列控制器

9 針腳 x1

12 V 觸發器

12 V 直流 (最大 0.5 A) x1

有線遙控

電話插孔 x1

輸入端子

電腦輸入

RGB 輸入

D-Sub 15 針腳 (母端) x1

DVI-D x1

視訊訊號輸入

VIDEO

RCA 插孔 x1

S-Video mini 4 針腳插孔 x1

SD/HDTV 訊號輸入

類比 - 色差

HDMI 輸入 x1

HDBaseT/LAN 輸入 x1

RCA 插孔 x3

BNC 插孔 x5

環境需求

操作溫度

5°C-40°C (海平面時)

操作相對溼度

10%-90% (無凝結狀態)

操作海拔

0-1499 公尺 (0°C-35°C)

1500-3000 公尺 (0°C-30°C)

(開啟高海拔模式)