



PU9730 / PW9620 / PX9710

Digital Projector

Quick Start Guide

Kurzanleitung

Guía de inicio rápido

Guide de démarrage rapide

Guida rapida

Snabbstartsguide

Guia de iniciação rápida

Краткое руководство

快速使用指南

요약 설명서

クイックスタート ガイド

快速使用指南



ecoFACTS

csr.BenQ.com

- Arsenic-free optical glass
- BFR/PVC-free casing plastics
- PVC-free plastic packaging
- Verre optique exempt d'arsenic
- Boitier de plastique exempt de BFR/PVC
- Emballage de plastique exempt de PVC

BenQ.com

© 2014 BenQ Corporation.
All rights reserved. Rights of modification reserved.

P/N: 4JJC701.002

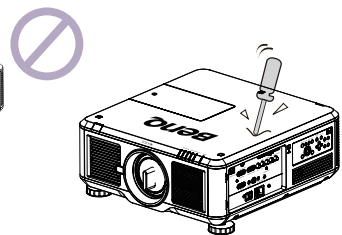
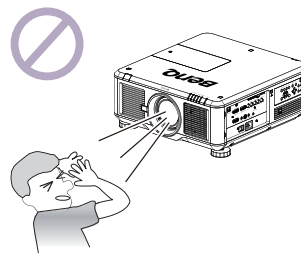
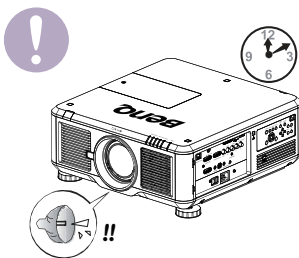
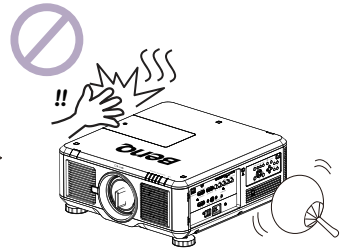
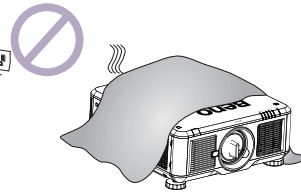
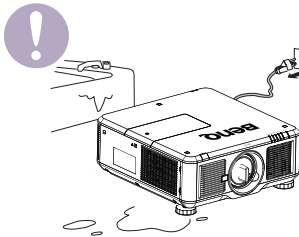
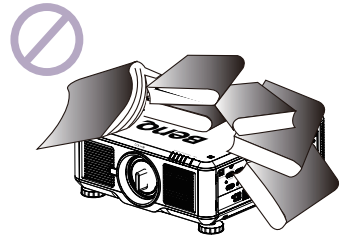
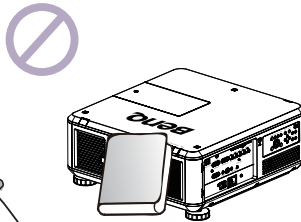
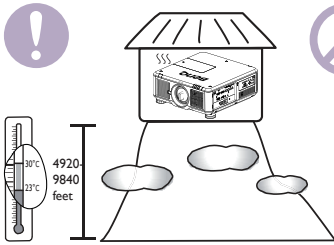
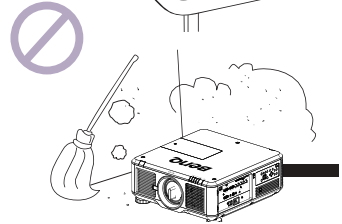
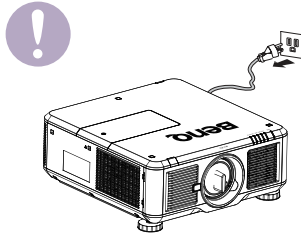
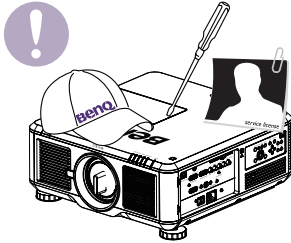
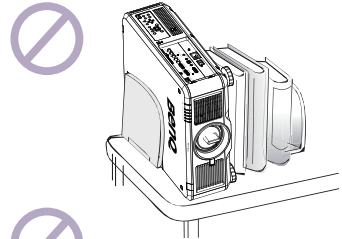
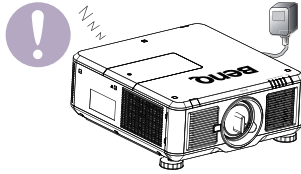
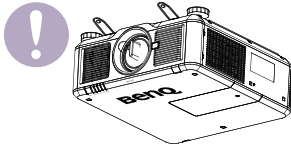
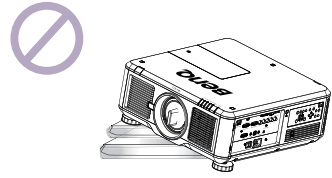
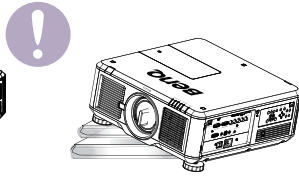
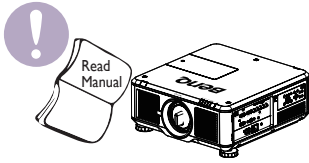

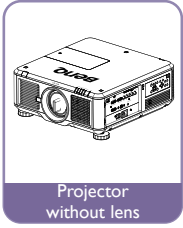

Projector
without lens



Remote
without AA batteries



Warranty card

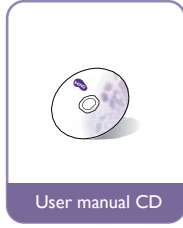

User manual CD



Quick start guide

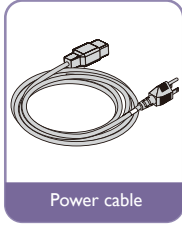

Power cable

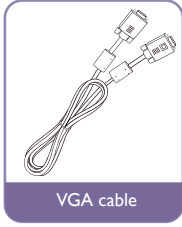

VGA cable

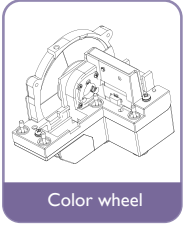

Color wheel



Anti-Theft Screw

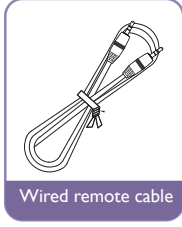

Wired remote cable

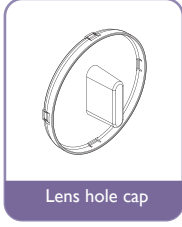

Lens hole cap

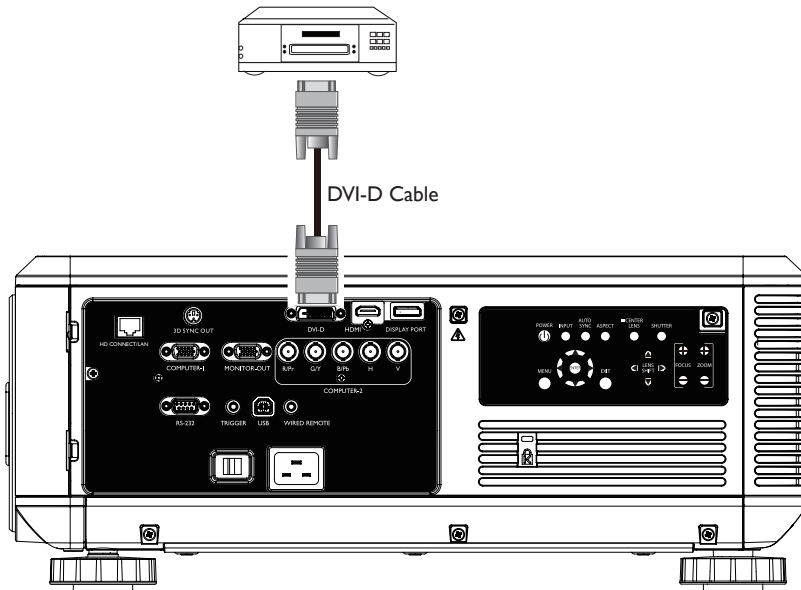
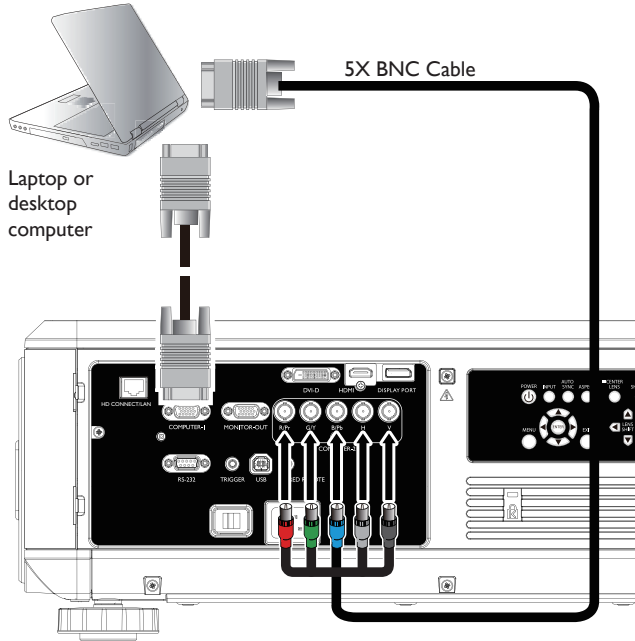

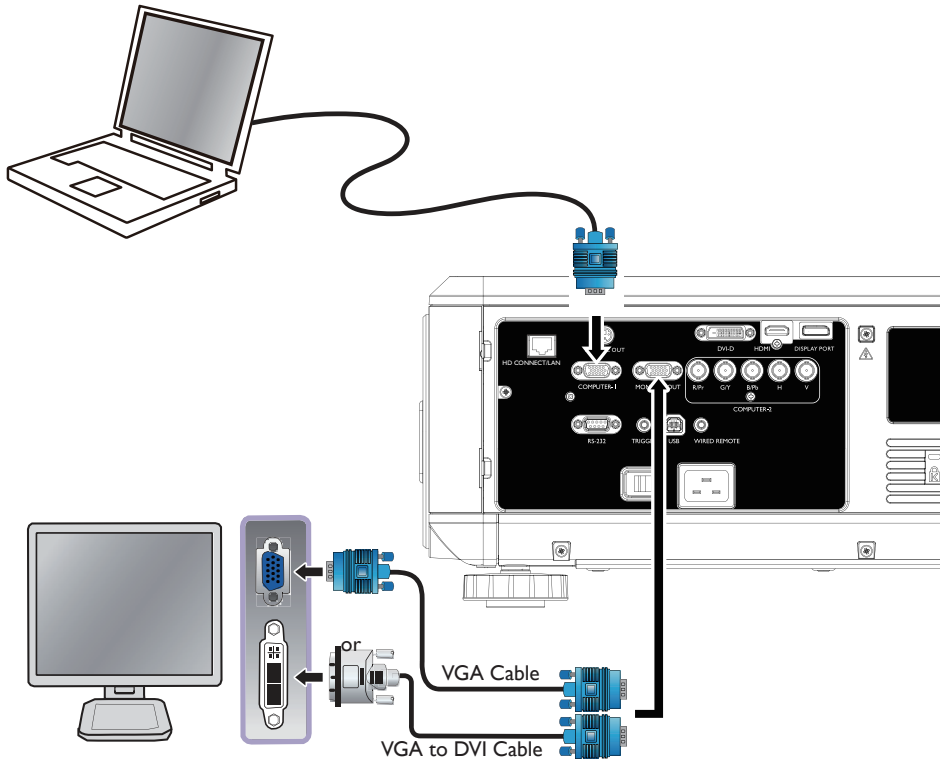

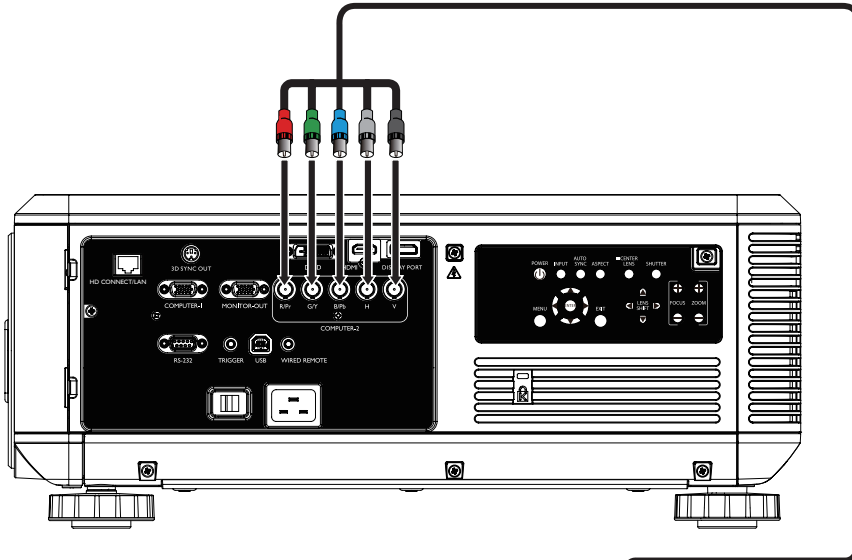

VGA Cable

AV equipment: DVD player,
digital tuner, etc.

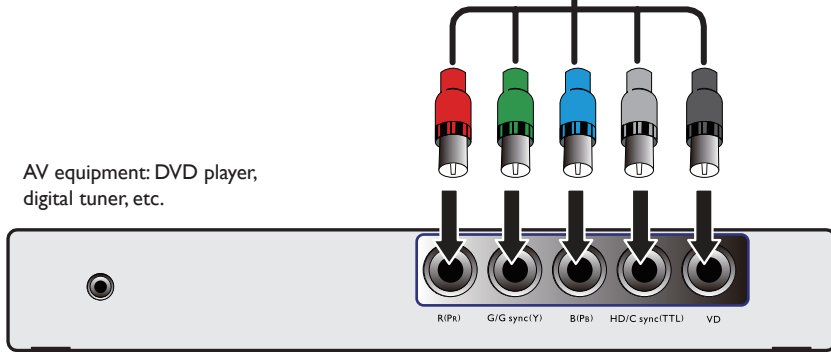

Ceiling Mount Installation

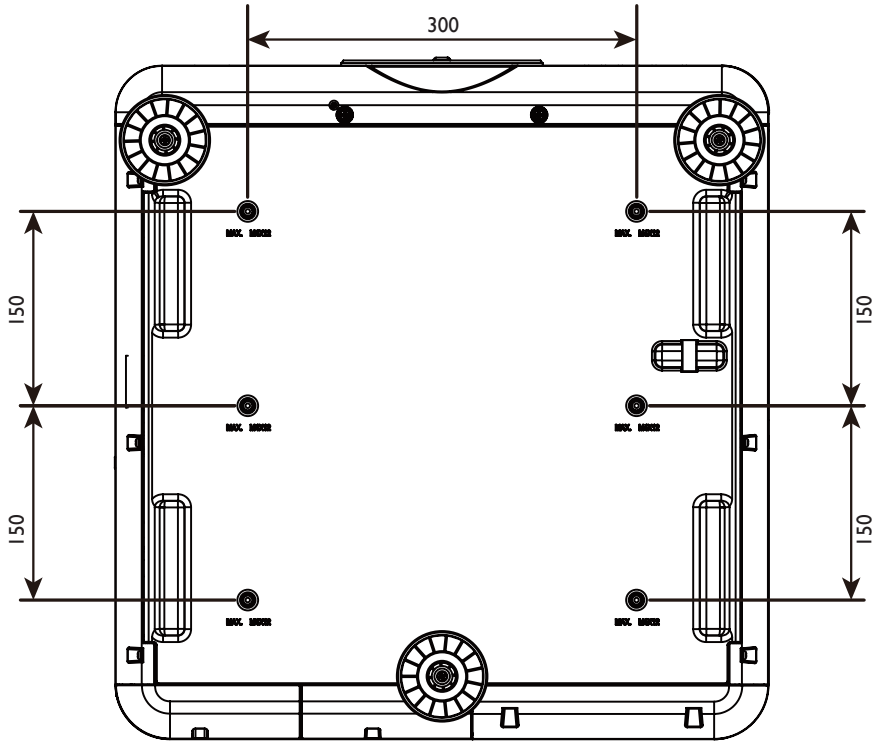

Unit: mm

(Mounting Screw: M4*12mm)

Projection dimensions

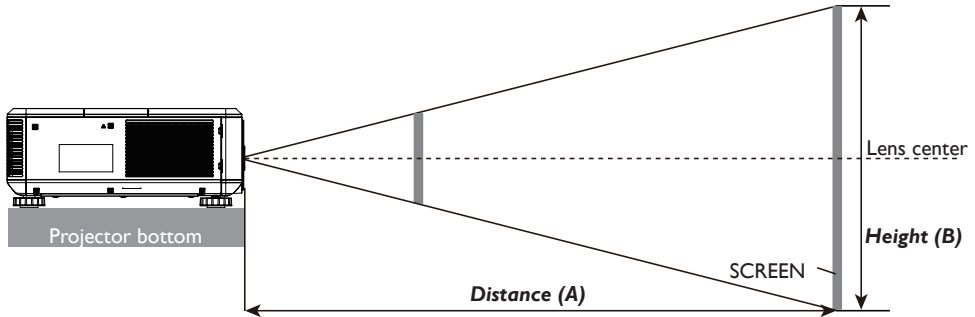

PU9730

Screen Size			SjJAM37.01		SjJAM37.02		SjJAM37.00				SjJAM37.05								
			Wide Fix Lens		Wide Zoom Lens		Standard Lens				Semi long Zoom I								
Diagonal	Width		Height(B)		Distance(A)														
					N/A		Wide		Tele		Wide		Tele		Wide		Tele		
(inch)	(m)	(inch)	(m)	(inch)	(m)	(inch)	(m)	(inch)	(m)	(inch)	(m)	(inch)	(m)	(inch)	(m)	(inch)	(m)	(inch)	(m)
40	1.02	34	0.86	21	0.54	25.1	0.64	41.4	1.05	59.9	1.52	57.2	1.45	75.8	1.93	73.6	1.87	124.1	3.15
50	1.27	42	1.08	26	0.67	31.8	0.81	52.3	1.33	75.4	1.92	72.1	1.83	95.5	2.42	92.9	2.36	155.9	3.96
60	1.52	51	1.29	32	0.81	38.5	0.98	63.1	1.60	90.9	2.31	87.1	2.21	115.1	2.92	112.1	2.85	187.8	4.77
80	2.03	68	1.72	42	1.08	52.0	1.32	84.9	2.16	121.8	3.09	117.0	2.97	154.3	3.92	150.5	3.82	251.4	6.39
100	2.54	85	2.15	53	1.35	65.5	1.66	106.6	2.71	152.7	3.88	147.0	3.73	193.5	4.92	188.9	4.80	315.0	8.00
120	3.05	102	2.58	64	1.62	78.9	2.01	128.4	3.26	183.6	4.66	176.9	4.49	232.8	5.91	227.6	5.78	378.6	9.62
150	3.81	127	3.23	79	2.02	99.1	2.52	161.0	4.09	230.0	5.84	221.8	5.63	291.6	7.41	285.0	7.24	474.1	12.04
180	4.57	153	3.88	95	2.42	119.3	3.03	193.6	4.92	276.4	7.02	266.7	6.77	350.5	8.90	342.6	8.70	569.5	14.47
200	5.08	170	4.31	106	2.69	132.8	3.37	215.3	5.47	307.3	7.81	296.6	7.53	389.7	9.90	381.0	9.68	633.1	16.08
300	7.62	254	6.46	159	4.04	200.1	5.08	324.0	8.23	461.9	11.73	446.3	11.34	585.9	14.9	573.2	14.56	951.2	24.16
400	10.16	339	8.62	212	5.38	267.4	6.79	432.7	10.99	616.6	15.66	595.9	15.14	782.3	19.87	765.3	19.44	1269.7	32.25
500	12.70	424	10.77	265	6.73	334.8	8.50	541.5	13.75	771.2	19.59	745.6	18.94	978.3	24.85	957.4	24.32	1587.8	40.33

Screen Size			SjJAM37.03				SjJAM37.04				SjJAM37.06						
			Long Zoom I Lens				Long zoom 2 Lens				Ultra Wide zoom Lens						
Diagonal	Width		Height(B)		Distance(A)												
					Wide		Tele		Wide		Tele		Wide		Tele		
(inch)	(m)	(inch)	(m)	(inch)	(m)	(inch)	(m)	(inch)	(m)	(inch)	(m)	(inch)	(m)	(inch)	(m)	(inch)	(m)
40	1.02	34	0.86	21	0.54	118.7	3.01	181.0	4.60	173.9	4.42	277.7	7.05	24.5	0.62	31.1	0.79
50	1.27	42	1.08	26	0.67	149.7	3.80	227.6	5.78	220.2	5.59	350.0	8.89	31.1	0.79	39.2	1.00
60	1.52	51	1.29	32	0.81	180.7	4.59	274.1	6.96	266.6	6.77	422.3	10.73	37.6	0.96	47.4	1.20
80	2.03	68	1.72	42	1.08	242.7	6.16	367.3	9.33	359.4	9.13	567.0	14.40	50.8	1.29	63.8	1.62
100	2.54	85	2.15	53	1.35	304.3	7.73	460.4	11.70	452.1	11.48	711.6	18.07	63.9	1.62	80.2	2.04
120	3.05	102	2.58	64	1.62	366.7	9.31	553.6	14.06	544.9	13.84	856.2	21.75	77.1	1.96	96.6	2.45
150	3.81	127	3.23	79	2.02	459.4	11.67	693.3	17.61	684.0	17.37	1073.1	27.26	96.8	2.46	121.1	3.08
180	4.57	153	3.88	95	2.42	552.4	14.03	833.0	21.16	823.1	20.91	1290.1	32.77	116.5	2.96	145.7	3.70
200	5.08	170	4.31	106	2.69	614.7	15.6	926.4	23.53	915.9	23.26	1434.7	36.44	129.7	3.29	162.1	4.12
300	7.62	254	6.46	159	4.04	924.0	23.47	1392.1	35.36	1379.6	35.04	2157.8	54.81	195.4	4.96	244.0	6.20
400	10.16	339	8.62	212	5.38	1233.9	31.34	1857.9	47.19	1843.3	46.82	2880.9	73.18	261.2	6.63	325.9	8.28
500	12.70	424	10.77	265	6.73	1543.7	39.21	2323.6	59.02	2307.1	58.60	3604.0	91.54	326.9	8.30	407.7	10.36

PW9620

Screen Size						5JJAM37.011		5JJAM37.021				5JJAM37.001				5JJAM37.051							
Diagonal						Width		Height(B)		Wide Fix Lens		Wide Zoom Lens				STD Lens				Semi long Zoom I			
										Distance(A)													
						N/A		Wide		Tele		Wide		Tele		Wide		Tele					
(inch)	(m)	(inch)	(m)	(inch)	(m)	(inch)	(m)	(inch)	(m)	(inch)	(m)	(inch)	(m)	(inch)	(m)	(inch)	(m)	(inch)	(m)				
40	1.02	34	0.86	21	0.54	26.4	0.67	43.6	1.11	63.1	1.60	60.2	1.53	79.8	2.03	77.6	1.97	130.5	3.31				
50	1.27	42	1.08	26	0.67	33.5	0.85	55.0	1.40	79.3	2.01	75.9	1.93	100.4	2.55	97.8	2.48	163.9	4.16				
60	1.52	51	1.29	32	0.81	40.5	1.03	66.4	1.69	95.5	2.43	91.7	2.33	121.0	3.07	117.9	3.00	197.3	5.01				
80	2.03	68	1.72	42	1.08	54.7	1.39	89.3	2.27	128.0	3.25	123.1	3.13	162.3	4.12	158.3	4.02	264.1	6.71				
100	2.54	85	2.15	53	1.35	68.8	1.75	112.1	2.85	160.5	4.08	154.5	3.93	203.5	5.17	198.7	5.05	330.9	8.41				
120	3.05	102	2.58	64	1.62	82.9	2.11	135.0	3.43	193.0	4.90	186.0	4.72	244.7	6.22	239.0	6.07	397.7	10.10				
150	3.81	127	3.23	79	2.02	104.1	2.64	169.2	4.30	241.7	6.14	233.1	5.92	306.5	7.79	299.6	7.61	498.0	12.65				
180	4.57	153	3.88	95	2.42	125.3	3.18	203.5	5.17	290.4	7.38	280.3	7.12	368.4	9.36	360.1	9.15	598.2	15.19				
200	5.08	170	4.31	106	2.69	139.4	3.54	226.4	5.75	322.9	8.20	311.7	7.92	409.6	10.40	400.5	10.17	665.0	16.89				
300	7.62	254	6.46	159	4.04	210.0	5.33	340.6	8.65	485.3	12.33	468.9	11.91	615.7	15.64	602.3	15.30	999.0	25.38				
400	10.16	339	8.62	212	5.38	280.6	7.13	454.8	11.55	647.7	16.45	626.1	15.90	821.9	20.88	804.1	20.42	1333.1	33.86				
500	12.70	424	10.77	265	6.73	351.2	8.92	569.0	14.45	810.1	20.58	783.3	19.90	1028.0	26.11	1005.9	25.55	1667.1	42.35				

Screen Size						5JJAM37.031				5JJAM37.041				5JJAM37.061											
Diagonal						Width		Height(B)		Long Zoom 1 Lens								Long zoom 2 Lens				Ultra Wide zoom Lens			
										Distance(A)															
						Wide		Tele		Wide		Tele		Wide		Tele									
(inch)	(m)	(inch)	(m)	(inch)	(m)	(inch)	(m)	(inch)	(m)	(inch)	(m)	(inch)	(m)	(inch)	(m)	(inch)	(m)								
40	1.02	34	0.86	21	0.54	124.9	3.17	190.3	4.83	183.3	4.65	292.2	7.42	25.8	0.65	32.8	0.83								
50	1.27	42	1.08	26	0.67	157.5	4.00	239.2	6.08	232.0	5.89	368.1	9.35	32.7	0.83	41.4	1.05								
60	1.52	51	1.29	32	0.81	190.1	4.83	288.1	7.32	280.7	7.13	444.0	11.28	39.6	1.00	50.0	1.27								
80	2.03	68	1.72	42	1.08	255.2	6.48	385.9	9.80	378.1	9.60	595.9	15.13	53.3	1.35	67.3	1.71								
100	2.54	85	2.15	53	1.35	320.3	8.14	483.7	12.29	475.6	12.08	747.7	18.99	67.1	1.70	84.5	2.15								
120	3.05	102	2.58	64	1.62	385.5	9.79	581.5	14.77	573.0	14.55	899.6	22.85	80.9	2.05	101.8	2.59								
150	3.81	127	3.23	79	2.02	483.2	12.27	728.2	18.50	719.1	18.27	1127.3	28.63	101.6	2.58	127.6	3.24								
180	4.57	153	3.88	95	2.42	580.9	14.75	874.9	22.22	865.3	21.98	1355.1	34.42	122.2	3.10	153.5	3.90								
200	5.08	170	4.31	106	2.69	646.0	16.41	972.7	24.71	962.7	24.45	1506.9	38.28	136.0	3.45	170.8	4.34								
300	7.62	254	6.46	159	4.04	971.7	24.68	1461.8	37.13	1449.9	36.83	2266.2	57.56	204.9	5.20	257.0	6.53								
400	10.16	339	8.62	212	5.38	1297.3	32.95	1950.8	49.55	1937.1	49.20	3025.4	76.85	273.8	6.95	343.2	8.72								
500	12.70	424	10.77	265	6.73	1623.0	41.22	2439.8	61.97	2424.2	61.58	3784.7	96.13	342.7	8.70	429.4	10.91								

PX9710

Screen Size						5JJAM37.01 I				5JJAM37.02 I				5JJAM37.00 I				5JJAM37.05 I			
						Wide Fix Lens				Wide Zoom Lens				STD Lens				Semi long Zoom I			
Diagonal		Width		Height(B)		Distance(A)															
						N/A		Wide		Tele		Wide		Tele		Wide		Tele			
(inch)	(m)	(inch)	(m)	(inch)	(m)	(inch)	(m)	(inch)	(m)	(inch)	(m)	(inch)	(m)	(inch)	(m)	(inch)	(m)	(inch)	(m)	(inch)	(m)
40	1.02	32	0.81	24	0.61	24.5	0.62	40.4	1.03	58.5	1.49	55.8	1.42	74.1	1.88	71.9	1.83	121.3	3.08		
50	1.27	40	1.02	30	0.76	31.0	0.79	51.0	1.30	73.6	1.87	70.4	1.79	93.2	2.37	90.7	2.30	152.4	3.87		
60	1.52	48	1.22	36	0.91	37.6	0.96	61.6	1.57	88.8	2.25	85.1	2.16	112.4	2.86	109.5	2.78	183.5	4.66		
80	2.03	64	1.63	48	1.22	50.8	1.29	82.9	2.11	119.0	3.02	114.3	2.90	150.8	3.83	147.0	3.73	245.7	6.24		
100	2.54	80	2.03	60	1.52	63.9	1.62	104.1	2.65	149.2	3.79	143.5	3.65	189.1	4.80	184.6	4.69	307.9	7.82		
120	3.05	96	2.44	72	1.83	77.1	1.96	125.4	3.18	179.4	4.56	172.8	4.39	227.4	5.78	222.1	5.64	370.1	9.40		
150	3.81	120	3.05	90	2.29	96.8	2.46	157.3	3.99	224.8	5.71	216.7	5.50	285.0	7.24	278.4	7.07	463.4	11.77		
180	4.57	144	3.66	108	2.74	116.6	2.96	189.1	4.80	270.1	6.86	260.5	6.62	342.5	8.70	334.8	8.50	556.7	14.14		
200	5.08	160	4.06	120	3.05	129.7	3.30	210.4	5.34	300.3	7.63	289.8	7.36	380.8	9.67	372.3	9.46	618.9	15.72		
300	7.62	240	6.1	180	4.57	195.5	4.97	316.6	8.04	451.5	11.47	436.0	11.07	572.6	14.54	560.0	14.23	930.0	23.62		
400	10.16	320	8.13	240	6.1	261.3	6.64	422.9	10.74	602.6	15.31	582.2	14.79	764.3	19.41	747.8	18.99	1241.0	31.52		
500	12.70	400	10.16	300	7.62	327.1	8.31	529.1	13.44	753.7	19.14	728.5	18.50	956.1	24.28	935.5	23.76	1552.0	39.42		

Screen Size						5JJAM37.03 I				5JJAM37.04 I				5JJAM37.06 I			
						Long Zoom I Lens				Long zoom 2 Lens				Ultra Wide zoom Lens			
Diagonal		Width		Height(B)		Distance(A)											
						Wide		Tele		Wide		Tele		Wide		Tele	
(inch)	(m)	(inch)	(m)	(inch)	(m)	(inch)	(m)	(inch)	(m)	(inch)	(m)	(inch)	(m)	(inch)	(m)	(inch)	(m)
40	1.02	32	0.81	24	0.61	115.9	2.94	176.8	4.49	169.6	4.31	271.2	6.89	23.9	0.61	30.4	0.77
50	1.27	40	1.02	30	0.76	146.2	3.71	222.3	5.65	215.0	5.46	341.9	8.68	30.3	0.77	38.4	0.98
60	1.52	48	1.22	36	0.91	176.5	4.48	267.9	6.80	260.3	6.61	412.6	10.48	36.7	0.93	46.5	1.18
80	2.03	64	1.63	48	1.22	237.1	6.02	358.9	9.12	350.9	8.91	554.0	14.07	49.5	1.26	62.5	1.59
100	2.54	80	2.03	60	1.52	297.7	7.56	450.0	11.43	441.6	11.22	695.3	17.66	62.4	1.58	78.6	2.00
120	3.05	96	2.44	72	1.83	358.2	9.10	541.0	13.74	532.2	13.52	836.7	21.25	75.2	1.91	94.7	2.40
150	3.81	120	3.05	90	2.29	449.1	11.41	677.6	17.21	668.2	16.97	1048.8	26.64	94.4	2.40	118.8	3.02
180	4.57	144	3.66	108	2.74	540.0	13.72	814.2	20.68	804.1	20.42	1260.9	32.03	113.7	2.89	142.9	3.63
200	5.08	160	4.06	120	3.05	600.6	15.26	905.3	22.99	894.8	22.73	1402.2	35.62	126.5	3.21	158.9	4.04
300	7.62	240	6.1	180	4.57	903.6	22.95	1360.5	34.56	1348.0	34.24	2109.1	53.57	190.7	4.84	239.2	6.08
400	10.16	320	8.13	240	6.1	1206.6	30.65	1815.8	46.12	1801.2	45.75	2816.0	71.53	254.9	6.47	319.5	8.12
500	12.70	400	10.16	300	7.62	1509.5	38.34	2271.1	57.69	2254.3	57.26	3522.9	89.48	319.1	8.10	399.9	10.16

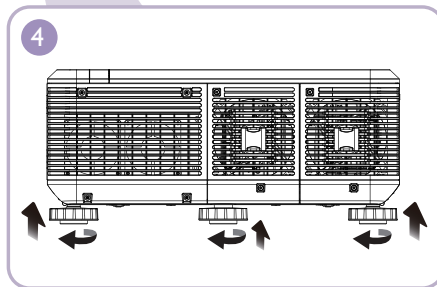
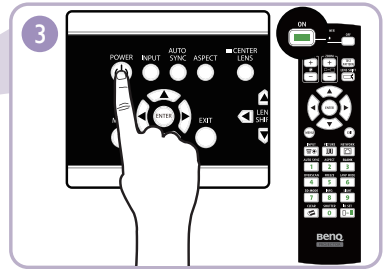
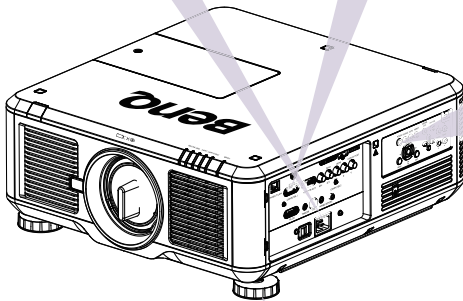
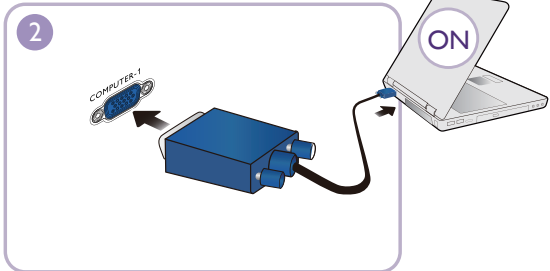
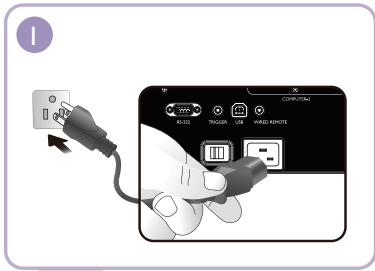

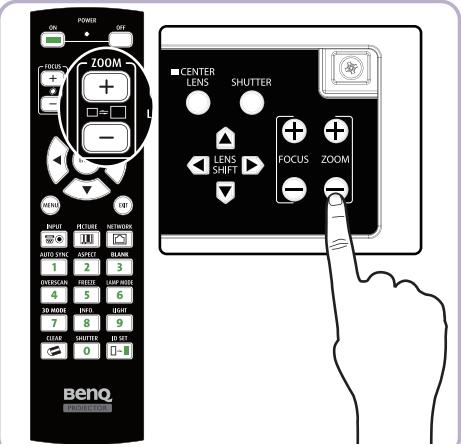
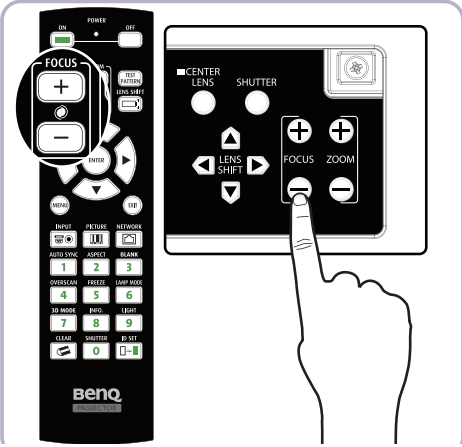
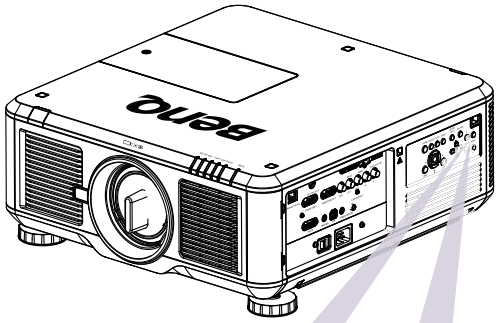
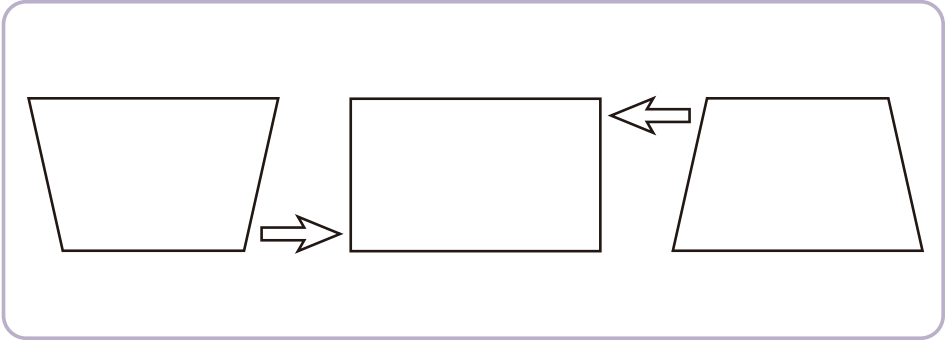

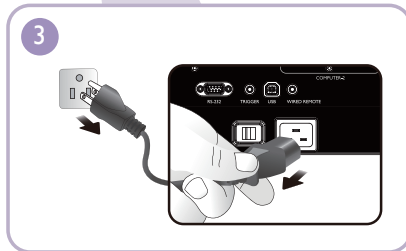
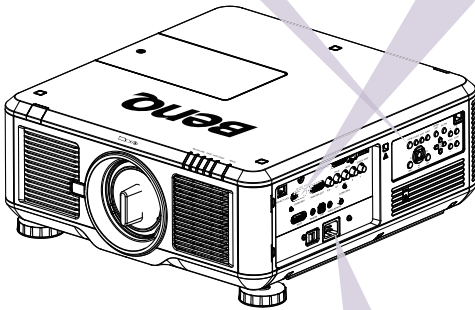
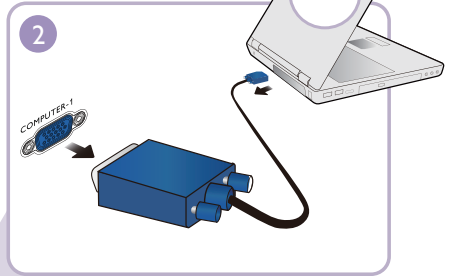
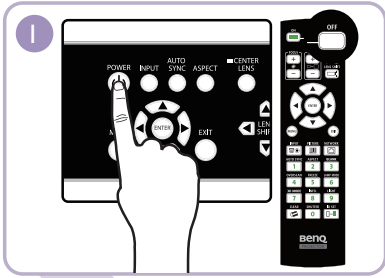

- EN For further information, please refer to the enclosed user manual.
- GM Weiter Informationen finden Sie im beiliegenden Benutzerhandbuch.
- SP Para más informaci3, consulte el manual de usuario adjunto.
- FR Pour plus d'informations, veuillez consulter le manuel d'utilistion fourni.
- IT Per ulteriori informazioni, consultare il manuale utente in dotazione.
- SW Se den medf3ljande anv3ndarhandboken f3r mer information.
- PR Para mais informa33es, consulte o manual do utilizador fornecido.
- RU Дoпoлнитeльные сведения см. в прилагаeмом руководстве пользователя.
- SC 要了解更多信息，请参见所付的用户手册。
- KR 자세한 내용은 동봉 된 사용 설명서를 참조하십시오 .
- JP 詳細は、付属のユーザー マニュアルを参照ください。
- TC 如需詳細資訊，請參閱附件的使用手冊。

Table of contents

English	17
Deutsch	18
Español	19
Français I	20
Italiano.....	21
Svenska.....	22
Português	23
Русский	24
简体中文.....	25
한국의	26
日本語	27
繁體中文.....	28



Specifications



All specifications are subject to change without notice.

Optical

Resolution

WUXGA / WXGA / XGA

Display system

Single-chip DLP™ system

Lamp

dual 350W lamp

Electrical

Power supply

AC 110-240V, 10A

50/60 Hz

Power consumption

880W (max); < 0.5W (Standby)

Mechanical

Weight

21kg / 45 lb

Output terminals

Monitor out

D-Sub 15pin x1

3D signal output

VESA 3pin mini din x1

Control

USB

Type A

RS-232 serial control

9 pin x1

12V TRIGGER

12VDC (Max. 0.5A) x1

Wired Remote

Phone jack x1

Input terminals

Computer input

RGB input

D-Sub 15-pin (female) x1

BNC input x5

Display Port input x1

SD/HDTV signal input

Analog-Component

DVI-D input x1

HDMI input x1

HD connect input x1

Environmental Requirements

Operating temperature

5°C-40°C at sea level

Operating relative humidity

10%-90% (without condensation)

Operating altitude

0-1499 m at 0°C-35°C

1500-3000 m at 0°C-30°C

(with High Altitude Mode on)



Alle Daten können ohne Bekanntmachung geändert werden.

Optische Daten

Auflösung

WUXGA / WXGA / XGA

Anzeigesystem

Einzel-Chip DLP™ System

Lampe

Dual 350 W Lampe

Elektrische Anschlusswerte

Stromversorgung

AC 110-240 V, 10 A

50/60 Hz

Stromverbrauch

880 W (Max); < 0,5 W (Standby)

Weitere Daten

Gewicht

21 kg/45 lb

Ausgänge

Monitorausgang

D-Sub 15 Pin x1

3D Signalausgang

VESA 3 Pin Mini Din x1

Steuerung

USB

Typ A

Serielle RS-232-Steuerung

9 Pin x1

12 V AUSLÖSER

12 V DC (Max 0,5 A) x1

Kabellose Fernbedienung

Telefonbuchse x1

Eingänge

Computereingang

RGB-Eingang

D-Sub 15 Pin (weiblich) x1

BNC Eingang x5

Display Port Eingang x1

SD/HDTV-Eingangssignal

Analog-Component

DVI-D Eingang x1

HDMI Eingang x1

HD Anschlussingang x1

Umgebungsbedingungen

Betriebstemperatur

5°C-40°C auf Meereshöhe

Luftfeuchtigkeit bei Betrieb

10%-90% (nicht kondensierend)

Höhenlage bei Betrieb

0-1499 m bei 0°C-35°C

1500-3000 m bei 0°C-30°C

(mit Höhenmodus Ein)



Todas las especificaciones están sujetas a cambio sin previo aviso.

Óptica

Resolución

WUXGA / WXGA / XGA

Sistema de visualización

Sistema DLP™ de un solo chip

Lámpara

Lámpara doble de 350 W

Especificaciones eléctricas

Fuente de alimentación

CA 110-240 V, 10 A

50/60 Hz

Consumo de energía

880 W (máx.); < 0,5 W (espera)

Especificaciones mecánicas

Peso

21 kg/45 lb

Terminales de salida

Salida de monitor

1 D-Sub de 15 contactos

Salida de señal 3D

1 VESA mini din de 3 contactos

Control

USB

Tipo A

Control de serie RS-232

1 de 9 contactos

ACTIVADOR DE 12 V

1 de 12 V CC (máx. 0,5 A)

Mando a distancia con cable

1 toma de teléfono

Terminales de entrada

Entrada de ordenador

Entrada RGB

1 D-Sub de 15 contactos
(hembra)

5 entradas BNC

1 entrada Display Port

Entrada de señal de SD/HDTV

Analógica-componentes

1 entrada DVI-D

1 entrada HDMI

1 entrada de conexión HD

Requisitos medioambientales

Temperatura de funcionamiento

5°C-40°C a nivel del mar

Humedad relativa de funcionamiento

10% - 90% (sin condensación)

Altitud de funcionamiento

0-1499 m a 0°C-35°C

1500-3000 m a 0°C-30°C

(con el modo de altitud elevada
activado)



Toutes les caractéristiques peuvent être modifiées sans notification préalable.

Caractéristiques optiques

Résolution

WUXGA / WXGA / XGA

Système d'affichage

Système à une puce DLP™

Lampe

double lampe 350 W

Caractéristiques électriques

Alimentation

Secteur 110-240 V, 10 A
50/60 Hz

Consommation

880 W (max) ; < 0,5 W (veille)

Caractéristiques mécaniques

Poids

21 kg/45 lb

Terminaux de sortie

Sortie moniteur

1 D-Sub 15 broches

Sortie de signal 3D

1 VESA 3 broches mini din

Commande

USB

Type A

Contrôle série RS-232

1 x 9 broches

Déclencheur 12 V

1 x 12 V CC (Max. 0,5 A)

Télécommande câblée

1 prise téléphone

Terminaux d'entrée

Entrée ordinateur

Entrée RVB

1 D-Sub à 15 broches (femelle)

5 entrées BNC

1 entrée Display Port

Entrée de signal SD/HDTV

Analogique-Composantes

1 entrée DVI-D

1 entrée HDMI

1 entrée HD connect

Caractéristiques environnementales

Température de fonctionnement

5°C-40°C au niveau de la mer

Humidité relative en fonctionnement

10% à 90% (sans condensation)

Altitude de fonctionnement

0 à 1499 m, de 0°C à 35°C

1500 à 3000 m, de 0°C à 30°C

(avec Mode Haute altitude activé)



Specifiche tecniche



Tutte le specifiche sono soggette a modifiche senza preavviso.

Parte ottica

Risoluzione

WUXGA / WXGA / XGA

Sistema di visualizzazione

Sistema DLP™ a chip singolo

Lampada

due lampade da 350W

Parte elettrica

Alimentazione

CA 110-240V, 10A

50/60 Hz

Consumo energetico

880W (max); < 0,5W (Standby)

Parte meccanica

Peso

21 kg/45 lb

Terminali di uscita

Uscita monitor

1 D-sub a 15 pin

Uscita segnale 3D

1 mini din VESA a 3 pin

Controllo

USB

Tipo A

Controllo seriale RS-232

1 a 9 pin

INTERRUTTORE 12V

1 a 12V CC (Max 0,5A)

Controllo cablato

1 jack telefono

Terminali di ingresso

Ingresso da computer

Ingresso RGB

1 D-Sub da 15-pin (femmina)

5 ingressi BNC

1 ingresso Display Port

Ingresso segnale SD/HDTV

Analogico-Componente

1 ingresso DVI-D

1 ingresso HDMI

1 ingresso connessione HD

Requisiti ambientali

Temperatura operativa

5°C-40°C a livello del mare

Umidità relativa operativa

10%-90% (senza condensa)

Altitudine operativa

0-1499 m a 0°C-35°C

1500-3000 m a 0°C-30°C

(con Modalità altitudine elevata attiva)



Alla specifikationer kan ändras utan föregående meddelande.

Optik

Upplösning

WUXGA / WXGA / XGA

Visningssystem

DLP™-enchipssystem

Lampa

två 350 W lampor

Elektricitet

Strömtillförsel

Växelström 110 V - 240 V, 10 A
50/60 Hz

Strömförbrukning

880 W (max); < 0,5 W (vänteläge)

Mekanik

Vikt

21 kg/45 lb

Utgångskontakter

Bildskärmsutgång

15-stifts D-Sub x1

3D-signalutgång

3-stifts VESA mini din x1

Kontroll

USB

Typ A

RS-232-seriekontroll

9-stifts x1

12 V UTLÖSARE

12 V likström (Max. 0,5 A) x1

Trådbunden fjärrkontroll

Telefonjack x1

Ingångskontakter

Datoringång

RGB-ingång

15-stifts D-Sub (hona) x1

BNC-ingång x5

Display Port-ingång x1

SD/HDTV-signalingång

Analog-Komponent

DVI-D-ingång x1

HDMI-ingång x1

HD-anslutningsingång x1

Miljökrav

Driftstemperatur

5°C - 40°C vid havsnivå

Relativ luftfuktighet vid drift

10% - 90% (icke-kondenserande)

Driftshöjd

0 - 1499 m vid 0°C - 35°C

1500 - 3000 m vid 0°C - 30°C

(med Höghöjdsläge aktiverat)



Todas as especificações estão sujeitas a alteração sem aviso prévio.

Ópticas

Resolução

WUXGA / WXGA / XGA

Sistema de ecrã

Sistema DLP™ de um só chip

Lâmpada

lâmpada 350 W dupla

Eléctricas

Fonte de alimentação

110-240 V CA, 10 A

50/60 Hz

Consumo de energia

880 W (máx); < 0,5 W (Em espera)

Mecânicas

Peso

21 kg/45 lb

Terminais de saída

Saída monitor

D-Sub 15 pinos x1

Saída de sinal 3D

VESA 3 pinos mini din x1

Controlo

USB

Tipo A

Controlo de série RS-232

9 pinos x1

ACCIONADOR 12 V

12 V CC (Máx. 0,5 A) x1

Controlo remoto com fios

Tomada telefónica x1

Terminais de entrada

Entrada para computador

Entrada RGB

D-Sub 15 pinos (fêmea) x1

Entrada BNC x5

Entrada Display Port x1

Entrada de sinal SD/HDTV

Analógico-Componente

Entrada DVI-D x1

Entrada HDMI x1

Entrada ligação HD x1

Requisitos Ambientais

Temperatura de funcionamento

5°C-40°C ao nível do mar

Humidade de funcionamento

10%-90% (sem condensação)

Altitude de funcionamento

0-1499 m a 0°C-35°C

1500-3000 m a 0°C-30°C

(Modo Grande Altitude ligado)



Все характеристики могут быть изменены без уведомления.

Оптические характеристики

Разрешение
WUXGA / WXGA / XGA

Проекционная система
Одночиповая система DLP™

Лампа

две лампы по 350 Вт

Электрические характеристики

Источник питания
110-240 В перем. тока, 10 А
Частота 50/60 Гц
Энергопотребление
880 Вт (макс.);
< 0,5 Вт (в режиме ожидания)

Механические характеристики

Масса
21 кг/45 фунта

Выходы

Выход монитора
15-контактный разъем D-sub -
1 шт.

Выход сигнала 3D
3-контактный разъем mini din
(VESA) - 1 шт.

Управление

USB
Тип А
Управление через
последовательный порт RS-232
9-контактный разъем - 1 шт.
ТРИГГЕР 12 В
12 В пост. тока (макс. 0,5 А) -
1 шт.

Проводной пульт ДУ
Телефонное гнездо - 1 шт.

Входы

Вход компьютера
Вход RGB
15-контактный разъем
D-Sub (гнездо) - 1 шт.
Вход BNC - 5 шт.
Вход Display Port - 1 шт.

Вход сигнала SD/HDTV
Аналоговый-компонентный
Вход DVI-D - 1 шт.
Вход HDMI - 1 шт.
Вход подключения HD - 1 шт.

Требования к условиям эксплуатации

Температура при работе
5°C-40°C на уровне моря
Относительная влажность при
работе
от 10% до 90%
(без образования конденсата)

Высота при работе
0-1499 м при температуре
0°C-35°C
1500-3000 м при температуре
0°C-30°C
(при включенном режиме
высокогорья)



所有规格如有更改，恕不另行通知。

光学

分辨率

WUXGA / WXGA / XGA

显示系统

单芯片 DLP™ 系统

灯泡

双灯 350W 灯泡

电气

电源

AC 110-240V, 10A

50/60 Hz

功耗

880W (最大); < 0.5W (待机)

机械

重量

21kg / 45 lb

输出端子

显示器输出

D-sub 15 针 x1

3D 讯号输出

VESA 3 针 mini din x1

控制

USB

Type A 型

RS-232 串口控制器

9 针 x1

12V 触发器

12V 直流 (最大 0.5A) x1

有线遥控

手机插孔 x1

输入

电脑输入

RGB 输入

D-Sub 15 针 (母) x1

BNC 输入 x5

Display port 输入 x1

SD/HDTV 信号输入

模拟 - 分量视频

DVI-D 输入 x1

HDMI 输入 x1

HD connect 输入 x1

环境要求

工作温度

海平面时 5°C-40°C

工作相对湿度

10%-90% (无冷凝)

操作高度

0°C-35°C 下 0-1499 米

0°C-30°C 下 1500-2000 米

(高海拔模式开启)



모든 사양은 사전 통보 없이 변경될 수 있습니다.

광학 사양

해상도

WUXGA / WXGA / XGA

디스플레이 시스템

단일칩 DLP™ 시스템

램프 사양

듀얼 350W 램프

전기 사양

전원 공급 장치

AC 110-240V, 10A

50/60 Hz

소비 전력

880W (최대); < 0.5W (대기)

기계 사양

무게

21 kg/45 lb

출력 단자

모니터 출력

D-Sub 15 핀 x1

3D 신호 출력

VESA 3 핀 미니 din x1

컨트롤

USB

타입 A

RS-232 직렬 컨트롤

9 핀 x1

12V 트리거

12V DC (최대 0.5A) x1

유선 리모컨

전화책 x1

입력 단자

컴퓨터 입력

RGB 입력

D-Sub 15 핀 (암) x1

BNC 입력 x5

Display Port 입력 x1

SD/HDTV 신호 입력

아날로그 컴포넌트

DVI-D 입력 x1

HDMI 입력 x1

HD 연결 입력 x1

환경 요건

작동 온도

5°C-40°C (해수면 기준)

작동 습도

10%-90% (비응결)

고도

0-1499 m, 0°C-35°C

1500-3000 m, 0°C-30°C

(높게 모드 켜짐)



仕様



仕様はすべて予告なしに変更されることがあります。

光学仕様

解像度

WUXGA / WXGA / XGA

ディスプレイ システム

シングルチップ DLP™ システム

ランプ

デュアル 350 W ランプ

電気仕様

電源

AC 110-240 V、10 A

50/60 Hz

電力消費量

880 W (最大) ; < 0.5 W (スタンバイ)

機械仕様

重量

21 kg/45 lb

出力端子

モニタ出力

D-Sub 15 ピン x1

3D 信号出力

VESA 3 ピン mini din x1

コントロール

USB

タイプ A

RS-232 シリアル コントロール

9 ピン x1

12 V トリガー

12 V DC (最大 0.5 A) x1

有線リモート

電話ジャック x1

入力端子

コンピュータ入力

RGB 入力

D-Sub 15- ピン (メス) x1

BNC 入力 x5

Display Port 入力 x1

SD/HDTV 信号入力

アナログ - コンポーネント

DVI-D 入力 x1

HDMI 入力 x1

HD 接続入力 x1

環境要件

動作温度範囲

5°C-40°C (海拔)

動作相対湿度

10%-90% (結露なきこと)

動作高度

0-1499 m (0°C-35°C)

1500-3000 m (0°C-30°C)

(高地対応モードオン)



所有規格如有更改，恕不另行通知。

光學

解析度

WUXGA / WXGA / XGA

顯示系統

單片式 DLP™ 系統

燈泡

雙燈 350W 燈泡

電氣

電源

AC 110-240V, 10A
50/60 Hz

消耗功率

880W (最大); < 0.5W (待機)

機械

重量

21kg / 45 lb

輸出端子

顯示器輸出

D-sub 15 針腳 x1

3D 訊號輸出

VESA 3pin mini din x1

控制

USB

Type A 類型

RS-232 序列控制器

9 針腳 x1

12V 觸發器

12V 直流 (最大 0.5A) x1

有線遙控

電話插孔 x1

輸入端子

電腦輸入

RGB 輸入

D-Sub 15 針腳 (母端) x1

BNC 輸入 x5

Display port 輸入 x1

SD/HDTV 訊號輸入

類比 - 色差

DVI-D 輸入 x1

HDMI 輸入 x1

HD connect 輸入 x1

環境需求

操作溫度

5°C-40°C(海平面時)

操作相對溼度

10%-90% (無冷凝狀態)

操作海拔

0-1499 公尺 (0°C-35°C)

1500-3000 公尺 (0°C-30°C)

(開啟高海拔模式)